



# Photomultipliers and Avalanche Photodiodes

Alan Fisher

*Stanford Linear Accelerator Center*

*Beam Diagnostics Using Synchrotron Radiation:  
Theory and Practice*

US Particle Accelerator School  
University of California, Santa Cruz  
2008 January 14-18



# Structure of a PMT

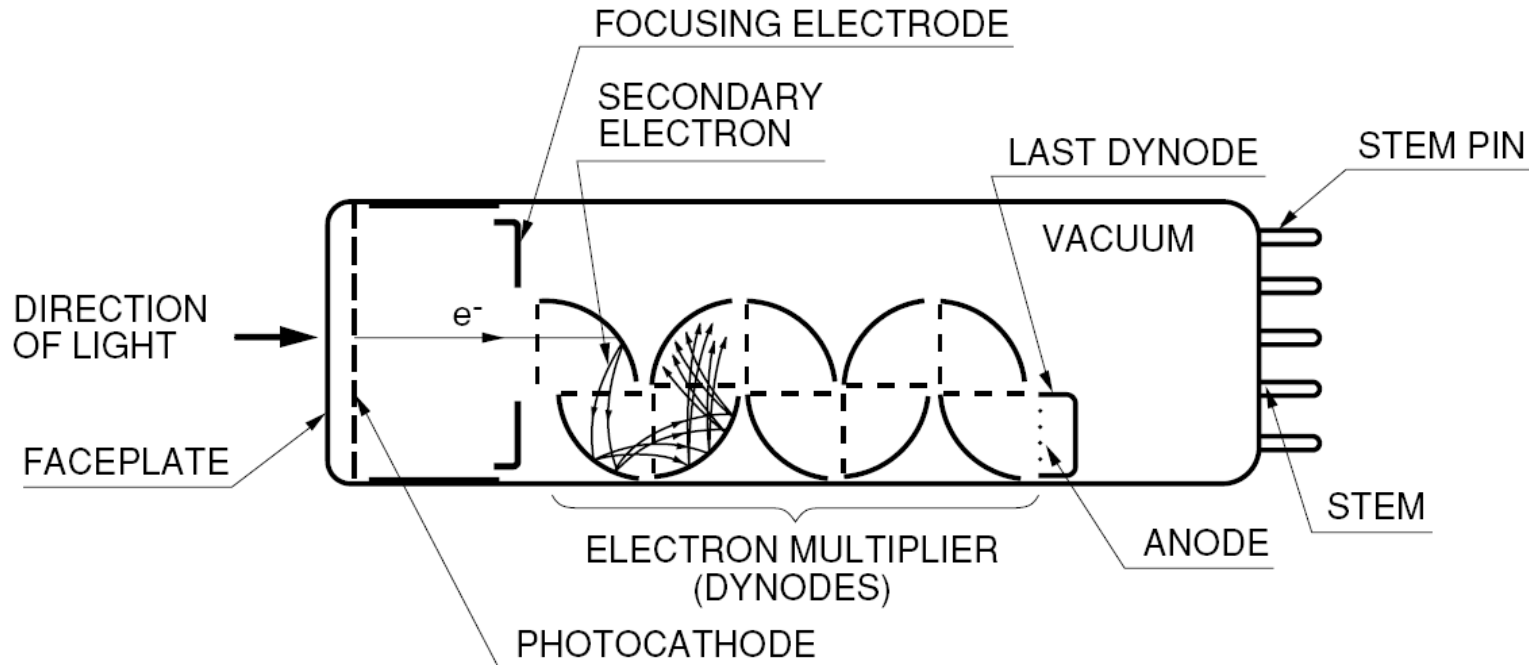

- Photocathode converts light to electrons.
- Dynodes multiply number of electrons by secondary emission.
  - Overall gain can be  $10^6$ , depending on applied voltage.
- Anode collects the resulting current.



# Many Sizes and Shapes

R3400-06:  
508 mm diameter

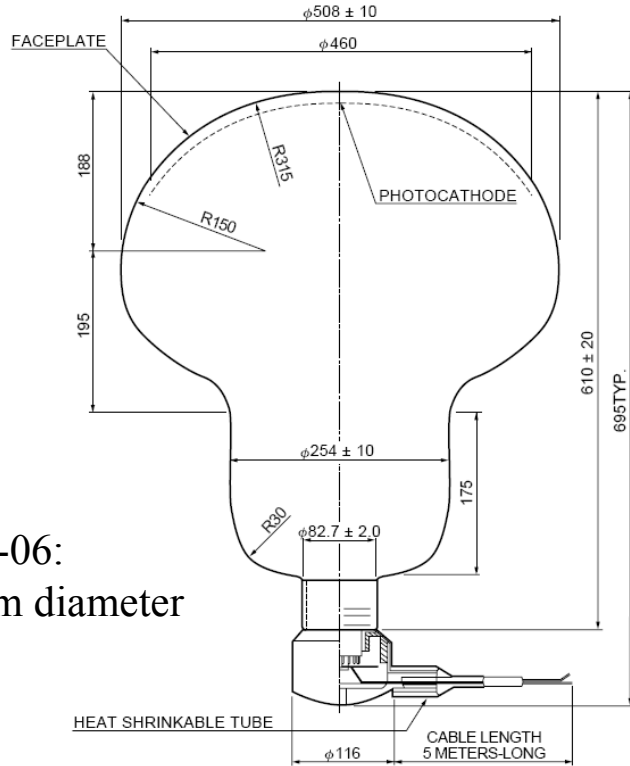

R7400U-06:  
16 mm diameter  
(our PMT)

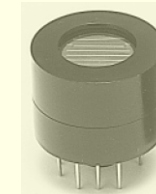
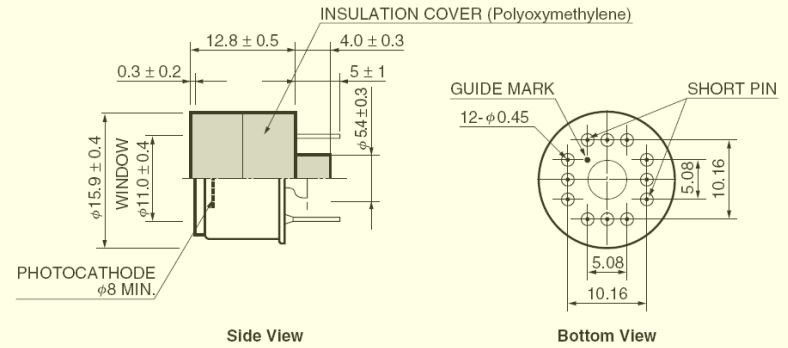

R8520:  
30 mm square

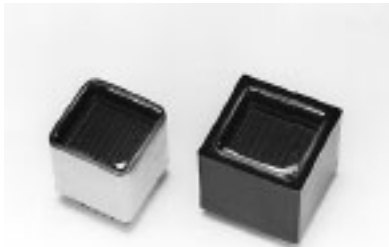

R9220:  
28 mm diameter  
side entry for light





# Window Materials

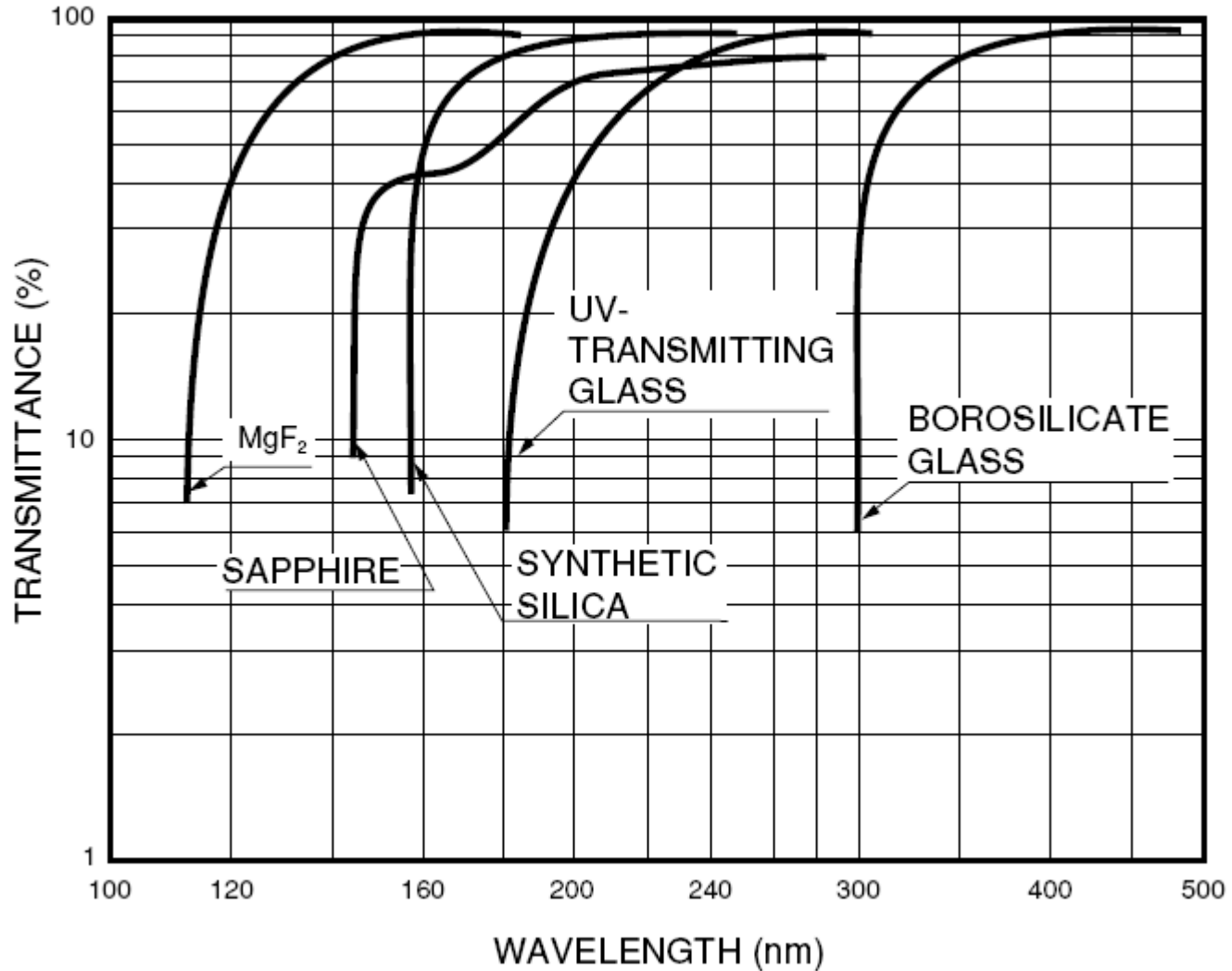



# Photocathodes and Quantum Efficiency

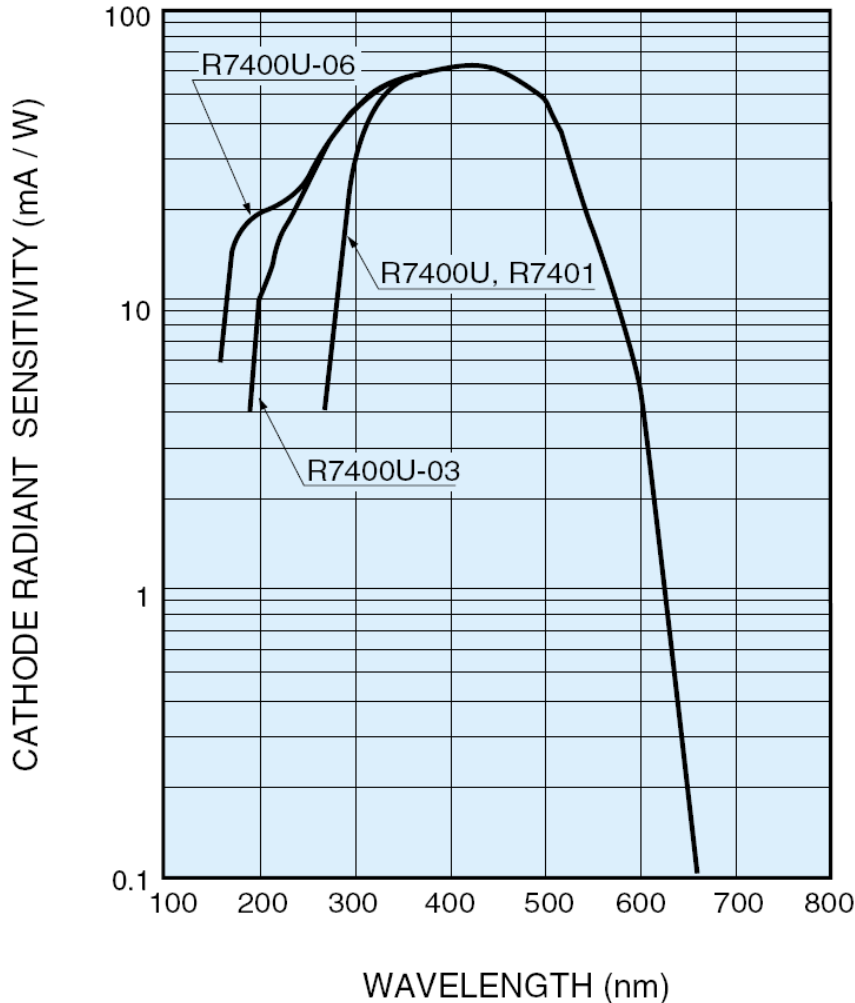

- The quantum efficiency  $\epsilon_{QE}$  of a photocathode is the number of photoelectrons emitted per arriving photon.
- The QE is related to the radiant sensitivity  $S$  (amps/watt, plotted at right) by:

$$\epsilon_{QE} = S \frac{hc}{e\lambda}$$

- We will use the Hamamatsu R7400U-06, which has a peak QE of 19%.



# Typical Photocathodes and Their QEs

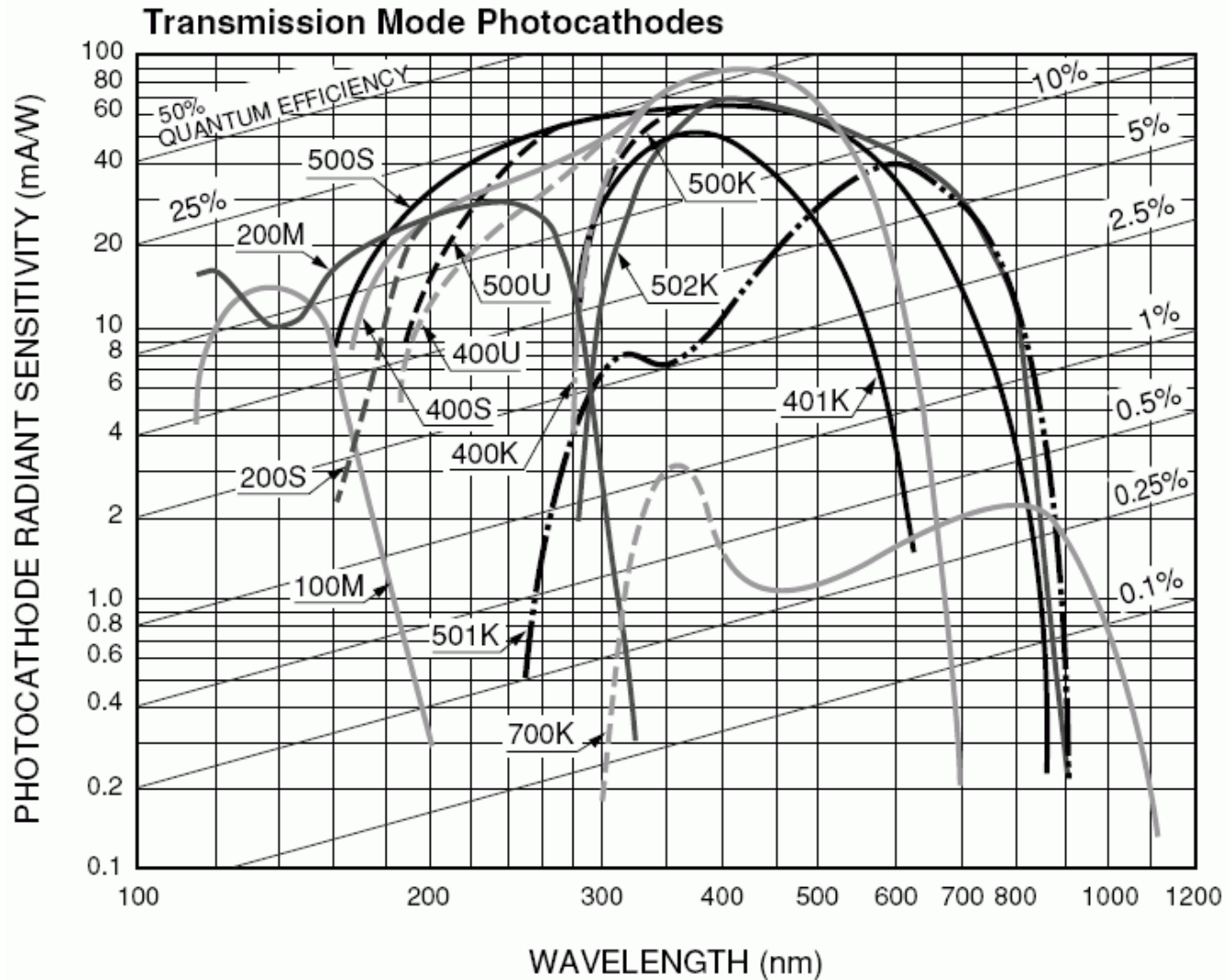



# Dynode Bias

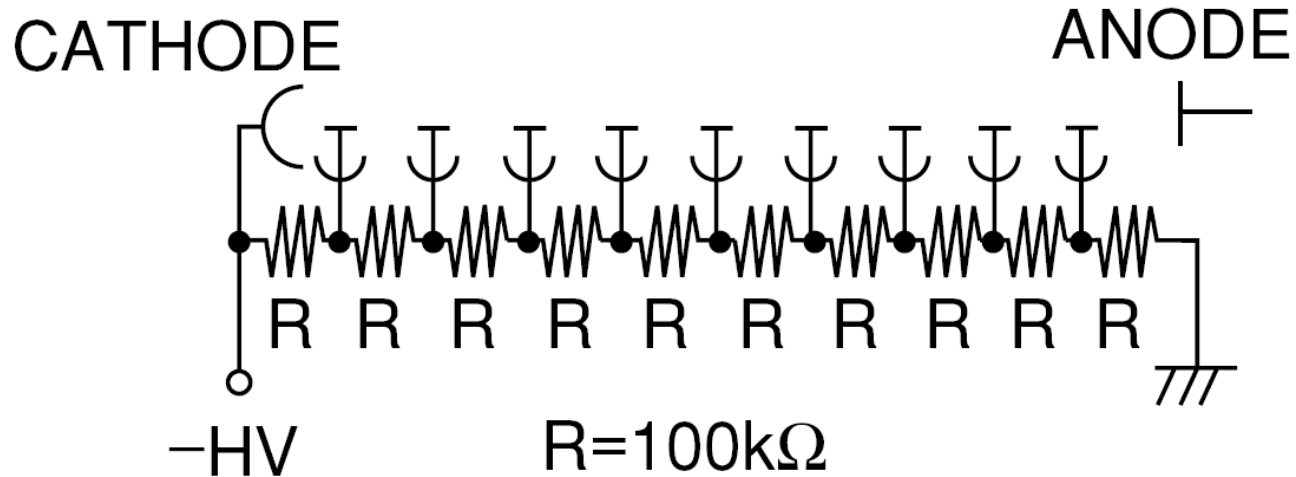

- Usually cathodes are at negative high voltage, from -500 V to -2 kV, and the anode is directly coupled to an oscilloscope or other devices.
  - Sometimes the anode is at +HV, and must then be connected to the scope through a DC-blocking capacitor.
- A resistor chain biases the dynodes at successively more positive voltages.



# Bias for our PMT

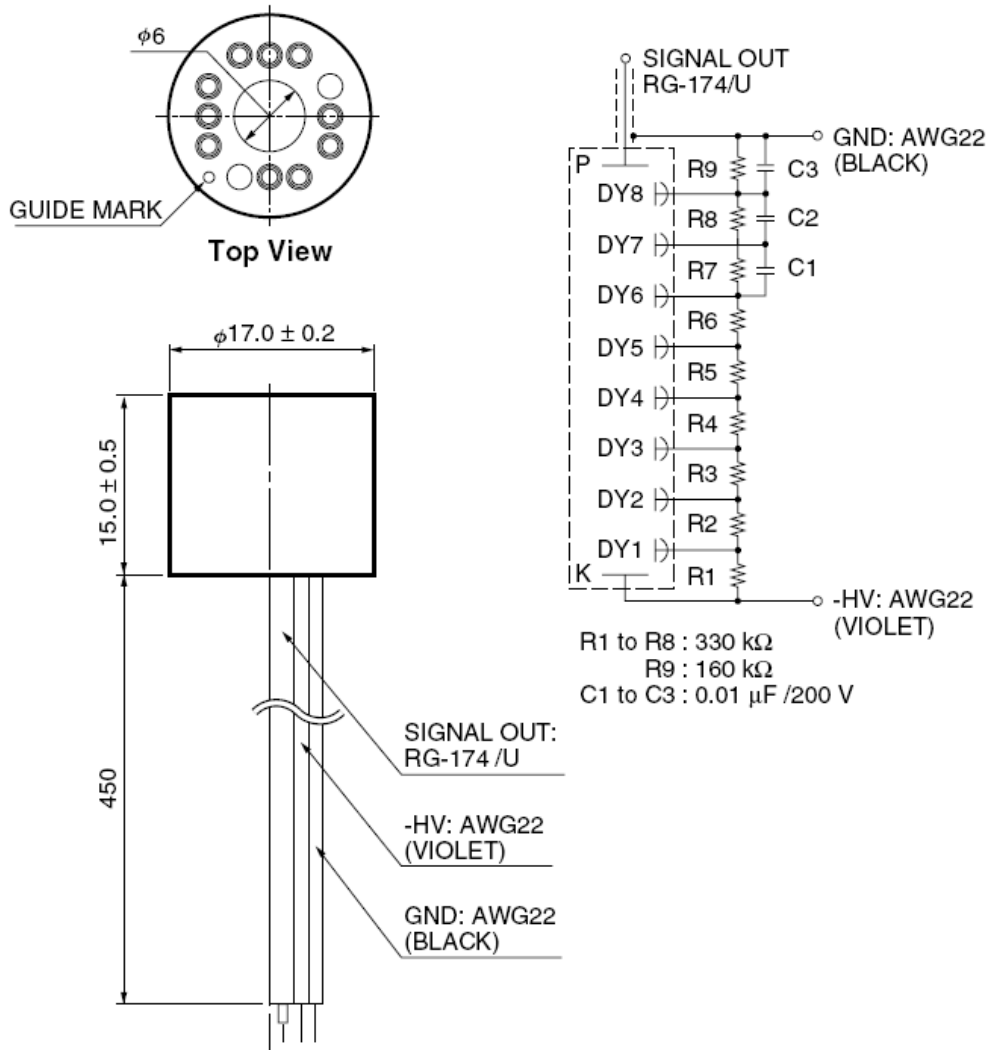

- A resistor chain is built into our PMT socket, a Hamamatsu E5780.
- Capacitors added to final dynodes supply large pulsed currents without reducing biasing current in the resistor chain.





# Dynode Structures

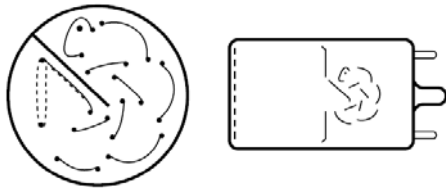

(1) Circular-cage Type



(3) Linear-focused Type

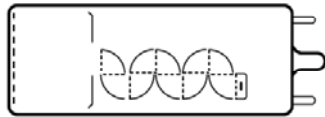

(2) Box-and-grid Type

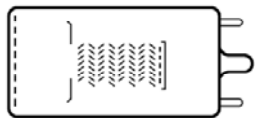

(4) Venetian Blind Type

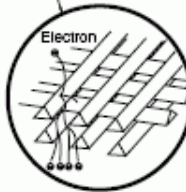

Coarse mesh

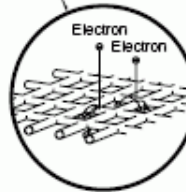

Fine mesh

(5) Mesh Type

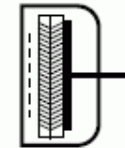

(6) Microchannel Plate Type

Our PMT has eight metal-channel dynodes.

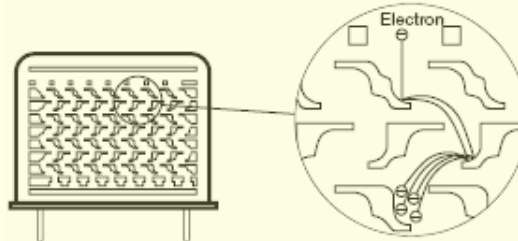

(7) Metal Channel Dynode Type

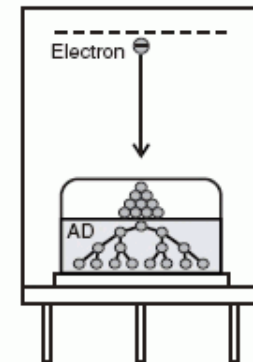

(8) Electron Bombardment Type



# Gain in the PMT

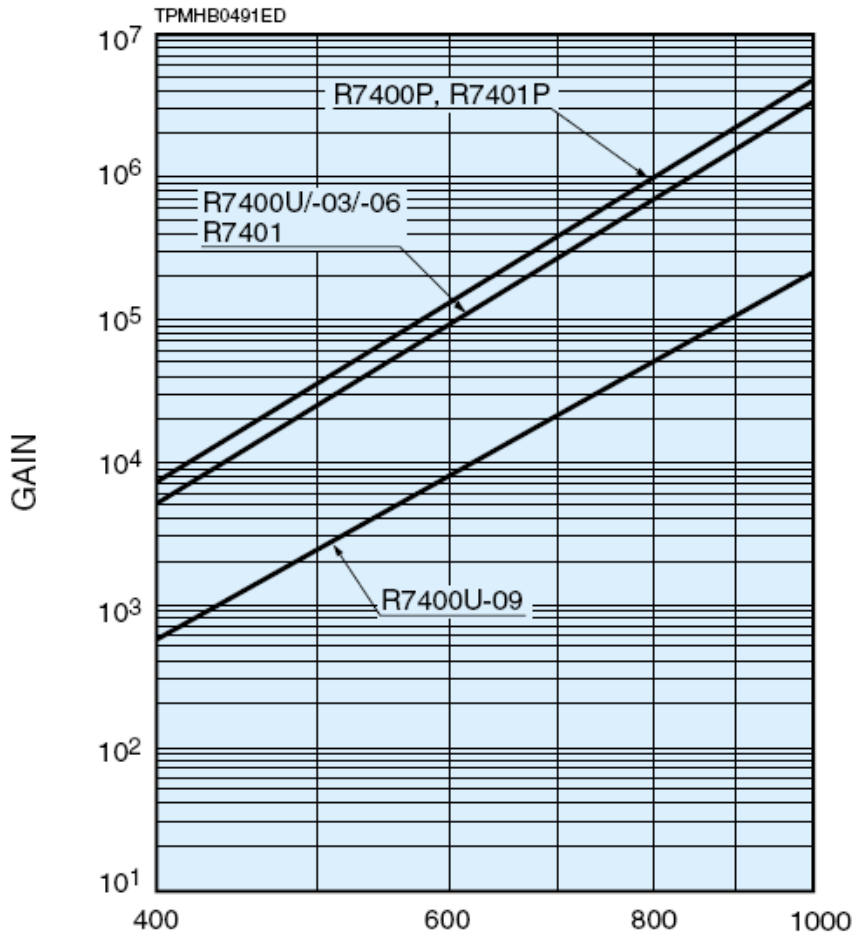

- At maximum voltage,  $V = 1$  kV, our PMT has a gain  
 $G = 3.2 \times 10^6$   
from the 8 dynodes.
- The gain per dynode is  
 $(3.2 \times 10^6)^{1/8} = 6.5$
- This gain is a function of the accelerating voltage  $v_i$  between adjacent dynodes stages:

$$g_i = av_i^k \text{ with } k \approx 0.75.$$



# Time Response of a Photomultiplier

- Transit-time delay: Dynode-to-dynode acceleration.
  - Example: 2 kV divided equally in a PMT with 9 dynodes that are 5 mm apart.
    - 10 acceleration stages (to each dynode and to anode) = 200 V/stage
    - Time per stage = 1.2 ns. Transit time for the tube = 12 ns.
- Pulse spread and rise time:
  - Secondaries emitted at random angles.
  - Take different paths to the next dynodes.
- Our small PMT has a faster response:
  - Transit time                      5.4 ns
  - Transit-time spread            0.23 ns
  - Rise time                         0.78 ns



# Noise in a Photomultiplier

- Noise in the PMT is due to shot noise at every stage.
  - Model as a Poisson process: Standard deviation = square root of the number of particles.
  - Dominant stage is the photocathode, where  $N_{ph}$  incoming photons produces a small number  $N_{pe}$  of photoelectrons.

$$\sigma_{pe} = \sqrt{N_{pe}} = \sqrt{\epsilon_{QE} N_{ph}}$$

- Dark current

- Electrons pulled from a surface by the voltage, producing a signal without light.

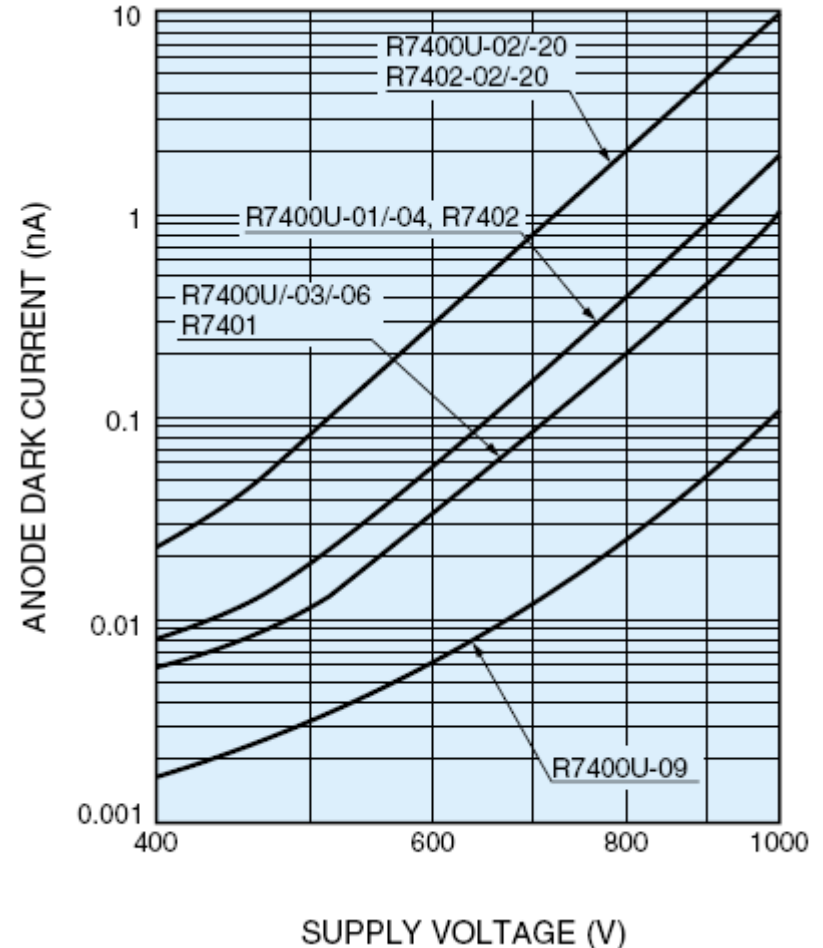



# Avalanche Photodiodes (APD)

- Used in the LBNL fluctuation experiment.
- Solid state with a single stage.
- Cathode diameters from 0.2 to 5 mm.
- Smaller cathode area and faster response than a PMT.
- Higher QE, but lower output than a PMT:
  - This APD: 20 A/W peak
  - Our PMT:
    - 62 mA/W at peak at cathode
    - Peak gain is  $3.2 \times 10^6$
    - Output of  $2.0 \times 10^5$  A/W. Useful for:
      - Weak light.
      - Short bursts of high current (with suitable dynode bias, including capacitors).

