



Pulsed Power Engineering Materials & Passive Components and Devices

June 13-17, 2011

Craig Burkhart & Mark Kemp
Power Conversion Department
SLAC National Accelerator Laboratory

Materials & Passive Components and Devices Used in Pulsed Power Engineering



- Materials
 - Conductors
 - Insulators
 - Magnetic material
- Passive components and devices
 - Resistors
 - Capacitors
 - Inductors
 - Transformers
 - Transmission lines
 - Loads
 - Klystrons
 - Beam kickers

Materials

- Generally encounter three types of materials in pulsed power work
 - Conductors
 - Wires & cable
 - Buss bars
 - Shielding
 - Resistors
 - Insulators
 - Cables and bushing
 - Standoffs
 - Capacitors
 - Magnetic
 - Inductors, transformers, and magnetic switches
 - Ferrite and tape-wound

Calculating Resistance

- At low frequency, resistance (R) determined by:
 - $R = \rho \ell / A$ (ohm)
 - Material resistivity, ρ ($\Omega \cdot \text{cm}$)
 - Conductor length, ℓ (cm)
 - Conductor cross-sectional area, A (cm^2)
- At high frequency, effective conductor area decreased by “skin effect”
 - Conducted current produces magnetic field
 - Magnetic field induces eddy currents in conductor which oppose/cancel B
 - Eddy currents decay due to material resistance, allow conducted current/magnetic field to penetrate material
 - Skin depth, δ , is the effective conducted current penetration ($B = B_{\text{applied}}/e$)
 - $\delta = (2\rho/\mu\omega)^{1/2}$ (meters) for a current of a fixed frequency $\omega=2\pi f$,
 $= (6.6/f^{1/2})[(\mu_0/\mu)(\rho/\rho_c)]^{1/2}$ or
 $\approx (2t\rho/\mu)^{1/2}$ (meters) for a pulsed current of duration t (sec)
 - Material resistivity, ρ ($\Omega \cdot \text{m}$)
 - Copper resistivity, $\rho_c = 1.7 \times 10^{-8}$ ($\Omega \cdot \text{m}$)
 - Material permeability, μ (H/m)
 - Permeability of free space, $\mu_0 = 4\pi \times 10^{-7}$ (H/m)
 - Litz wire is woven to minimize skin effects



Resistivity of Common Materials

Material	Resistivity @ 20° C
Aluminum	2.62 $\mu\Omega\cdot\text{cm}$
Be-Cu	5.4 – 11.5 $\mu\Omega\cdot\text{cm}$
Brass (66% Cu, 34% Zn)	3.9 $\mu\Omega\cdot\text{cm}$
Copper (OFHC)	1.72 $\mu\Omega\cdot\text{cm}$
Copper (water pipe)	2.1 $\mu\Omega\cdot\text{cm}$
Graphite (typical)	1.4 $\text{m}\Omega\cdot\text{cm}$
Gold	2.44 $\mu\Omega\cdot\text{cm}$
Indium	9 $\mu\Omega\cdot\text{cm}$
Iron	9.71 $\mu\Omega\cdot\text{cm}$
Silver	1.62 $\mu\Omega\cdot\text{cm}$
Stainless Steel (typical)	90 $\mu\Omega\cdot\text{cm}$
Steel (0.5% C)	13 – 22 $\mu\Omega\cdot\text{cm}$
Water (purified)	2 X 10 ⁷ $\Omega\cdot\text{cm}$ (maximum)
Water (tap)	10 ⁴ $\Omega\cdot\text{cm}$
Water/CuSO ₄	25 $\Omega\cdot\text{cm}$ (minimum)



Insulator Properties

- Insulators are used to isolate and support conductors of differing electric potential
- Typically characterized by two properties
 - Breakdown strength, E_{BD} , electric field which will arc through the material
 - Dielectric constant (relative), $\epsilon_r = \epsilon/\epsilon_0$
- Regularly use solid, liquid and gaseous (and vacuum) insulators in pulsed power engineering



Solid Dielectrics

- Can be used as structural elements
- Breakdown through material is irreparable
- Can also arc along surface, flashover, typically at $E \approx 0.5 E_{BD}$
- E_{BD} limited by material imperfections, voids, where corona can occur and gradually degrade material. Therefore E_{BD} decreases with increasing material thickness, as the probability of defects increases.
- $100 \text{ V/mil} < E_{BD} < 1 \text{ kV/mil}$ (typical, $>0.1''$) ($\text{kV/mil} \sim 0.4 \text{ MV/cm}$)
- $2 < \epsilon_r < 10$ (typical, excluding ceramic capacitor materials $\sim 10^3$)

Solid Dielectric Properties

Material	Diel. Const. 60 Hz.		Diel. Const. 1 MHz.		Diel. Strength* V/mil
	ϵ	$\tan \delta$	ϵ	$\tan \delta$	
Aluminum Oxide	8.80	3.3(-4)	8.80	320	320
Barium Titanate	1250	0.056	1143	0.0105	75
Soda-Borosilicate Glass	4.97	-----	4.84	3.6(-3)	400
Epoxy (Epon RN-48)	4.50	0.05	3.52	0.0142	800
Polycarbonate	3.17	0.009	2.96	0.01	400
Acrylic	4.0	0.016	2.55	0.009	400
Polyimide	3.4	0.002	3.4	0.003	570
Polyvinyl Chloride	3.20	0.0115	2.88	0.016	400
PTFE (Teflon)	2.10	<5(-4)	2.10	<2(-4)	550
Polyethylene	2.26	<2(-4)	2.26	<2(-4)	450
Polypropylene	2.55	<5(-4)	2.55	<5(-4)	650
Paper	3.30	0.010	2.99	0.038	200

*Typical DC values for .10 inch thick samples

From NSRC Pulse Power Formulary

$$Y(X) \equiv Y \cdot 10^X$$

Dielectric “Pool”: SNL Z-machine

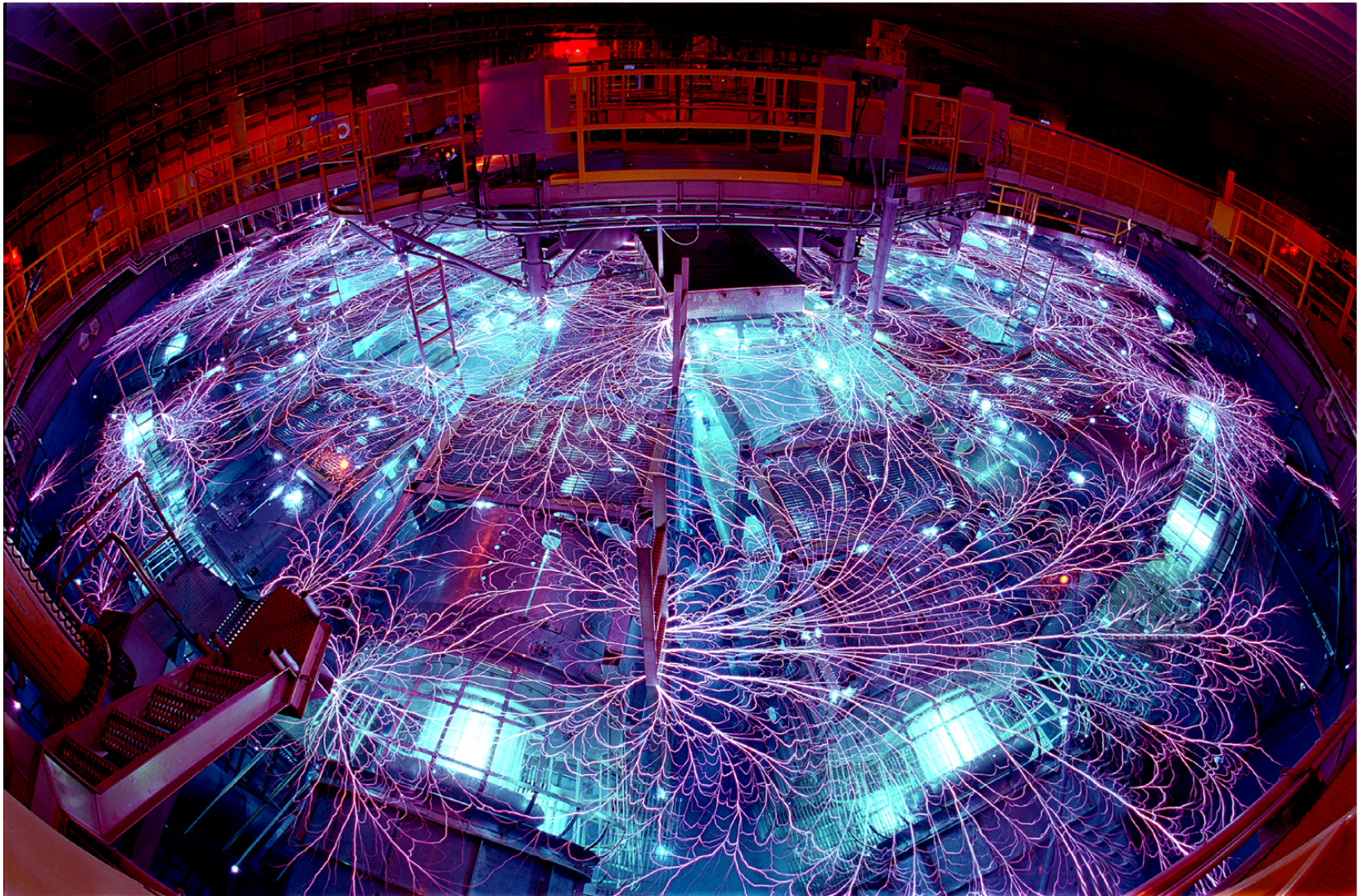



Liquid Dielectrics

- Breakdown damage can be “healed”
 - Arcing may result in conductive (typically carbon) residue
 - Circulation will disburse residue, reduce concentration below threshold
 - Filtration/processing can remove contamination
- Oil is the most common liquid insulator used in pulsed power (you are not a pulsed power engineer until you have been up to your armpits in oil)
- Water and Ethylene Glycol are often used in PFLs and capacitors
 - High dielectric constants increase pulse length and energy storage
 - Water: $\epsilon_r = 81$
 - Ethylene Glycol: $\epsilon_r = 41$
 - Because of low resistivity, can only be used for pulse-charged applications
 - $RC = \rho\epsilon \sim 2 \mu\text{s}$ maximum for water at 20°C (However, this can be increased to $\sim 100 \text{ ms}$ by mixing Ethylene Glycol, antifreeze, with the water and chilling the solution to near the freezing temperature.)
 - Breakdown strength
 - E_{BD} is weakly pulse length dependent (see Pulsed Power Formulary)
 - Typical pulsed operation: $\sim 50 - 200 \text{ kV/cm}$ (\sim half the strength of oil)



Dielectric Oils

- Mineral oils
 - Pulsed power work horse
 - Many trade names (e.g. Sontex, Diala AX), some with additives, electrical properties vary little
 - Polychlorinated Biphenyls (PCB) generally phased out in 60's, but may be present in older systems (new systems usually labeled as “PCB free”)
 - Increasing concern about the toxicity/environmental impact of these oils
 - Some plastic and rubber compounds will swell if immersed in mineral oil
 - Hydroscopic (absorbs water), but takes a lot to significantly degrade properties and can be removed by heating
 - Properties also degraded by entrainment oil air (avoid centrifugal pumps)
 - For best performance, should be circulated, filtered, de-watered and de-aerated
 - Dielectric constant: $\epsilon_r = 2.2$ (excellent match to many polymers)
 - Breakdown strength
 - E_{BD} is weakly pulse length dependent (see Pulsed Power Formulary)
 - Typical pulsed operation: $\sim 100 - 400$ kV/cm
 - Typical dc operation: ~ 40 kV/cm



Dielectric Oils (cont.)

- Silicon oils
 - High quality
 - Expensive
- Vegetable oils: castor, rapeseed, canola, etc.
 - Increased usage
 - Low toxicity/environmental impact
 - Properties may vary significantly from mineral oils
 - High viscosity, may not be functional at ambient temperatures
 - May support bacterial growth
 - Different dielectric constants; castor ~ 4.5
- Other “oils” used in high value applications (e.g. capacitors)
 - Isopropyl biphenyl
 - benzyltoluene diphenylethane
 - phenyl xylyl ethane
 - tricresyl phosphate
 - ethyl hexyl phthalate

Gaseous Dielectrics

- Breakdowns cause no permanent damage
 - Used for high power switches; spark gaps, thyratrons
 - Produces gas ionization
 - Ion/electron recombination time ~ms (shorter at higher pressure)
- Dielectric constant: $\epsilon_r = 1$ (low stored energy in stray capacitance)
- Corona (electrical discharge below the breakdown threshold) will ionize gas. This can produce chemical radicals (e.g. O_3) which can degrade system elements.
- Breakdown strength in air:
 - $E_{BD} \approx 25p + 6.7(p/d)^{1/2}$ (kV/cm)
 - Gas pressure, p (atm absolute)
 - Conductor spacing, d (cm)
 - Relative breakdown strength of gases:

• Air	1.0
• Nitrogen	1.0
• SF ₆	2.7
• H ₂	0.5
• 30% SF ₆ , 70% Air	2.0

Magnetic Material Properties

- Permeability, μ
 - $\mu(\text{H/m}) = B(\text{T})/H(\text{A/m})$
 - Often expressed as relative permeability, $\mu_r = \mu/\mu_0 = B(\text{G})/H(\text{Oe})$
 - $\mu_r \approx 25,000$ for Fe, 400 for Carbon steel
 - Permeability of free space, $\mu_0 = 4\pi \times 10^{-7} \text{ H/m}$
- Flux swing, ΔB
 - Change in flux density a material can support before it saturates ($\mu \rightarrow \mu_0$)
 - Typically from remnant flux ($H=0$), B_r , to saturation flux, B_s : $\Delta B = B_r + B_s$
- Hysteresis loop
 - Plot of B vs H
 - Slope is μ
 - Area is energy

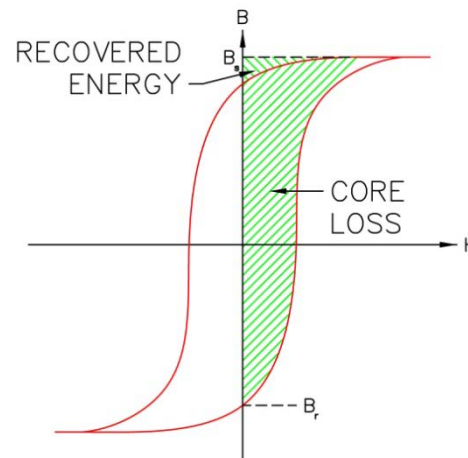

Magnetic Material Properties (cont.)

- Faraday's law
 - $\int \mathbf{B} \cdot d\mathbf{A} = \int V dt$
 - $A_c \Delta B = V\tau$
 - Cross sectional area of core, A_c
 - Pulse voltage, V
 - Pulse duration, τ

- Ampere's law
 - $\int \mathbf{H} \cdot d\mathbf{l} = I$
 - $H = I/\ell_m$
 - Magnetizing current, I
 - Mean magnetic path length, $\ell_m = 2\pi (R_o - R_i) / \ln(R_o / R_i)$
(log mean circumference)

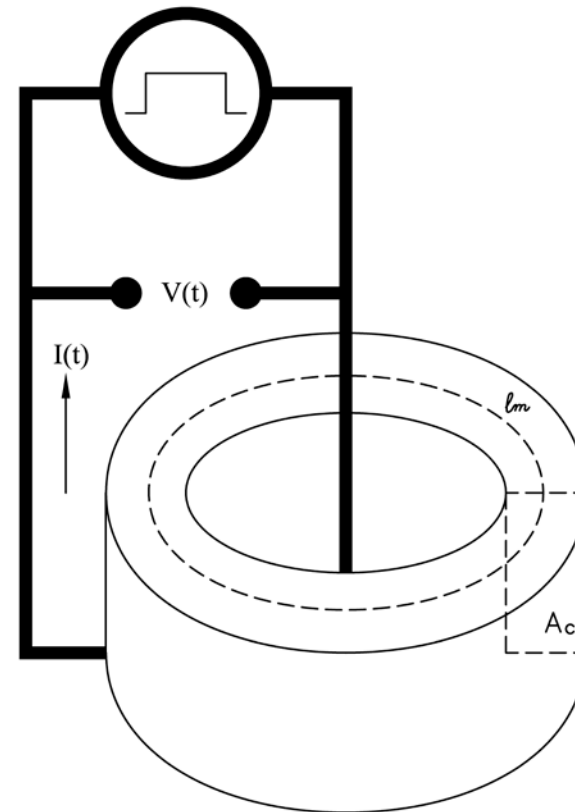

Magnetic Materials

- Two types of material are typically used
 - Ferrimagnetic materials: ferrite cores
 - μ_r : ~500 – 2000 (typical)
 - μ_r approximately constant to >MHz for some formulations
 - ρ : $\sim 10^9 \Omega \cdot \text{cm}$
 - ΔB : $\sim 0.5 \text{ T}$
 - Ferromagnetic materials: tape-wound cores
 - ρ : $\sim 10^{-5} \Omega \cdot \text{cm}$
 - Eddy currents impede field penetration into material (skin effect)
 - Must be wound from thin (0.001”) ribbon interleaved with insulator
 - Insulator does not have magnetic properties, effective area of magnetic material reduced by packing factor, $\eta = \text{insulator thickness}/\text{total tickness}$
 - μ_r : $> 10^4$
 - μ_r strong function of frequency in MHz range for even best materials
 - ΔB : $> 3 \text{ T}$
- Hysteresis characteristics of any material can be linearized by adding a gap to the core

Ferrite

- Two dominant compositions
 - NiZn
 - Highest frequency response
 - High frequency transformers & chokes, magnetic switching, induction accelerator cores
 - CN20, CMD5005, PE-11B

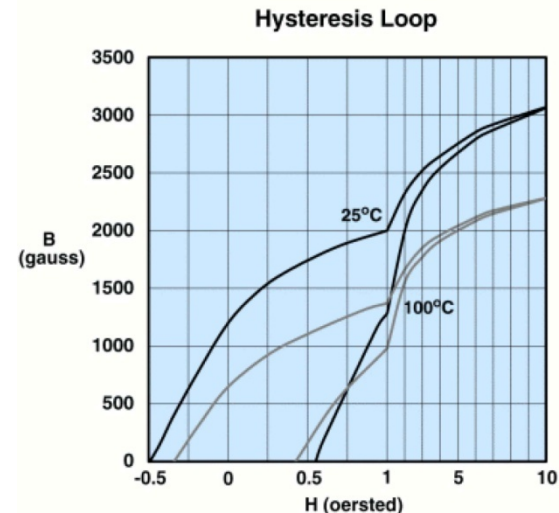
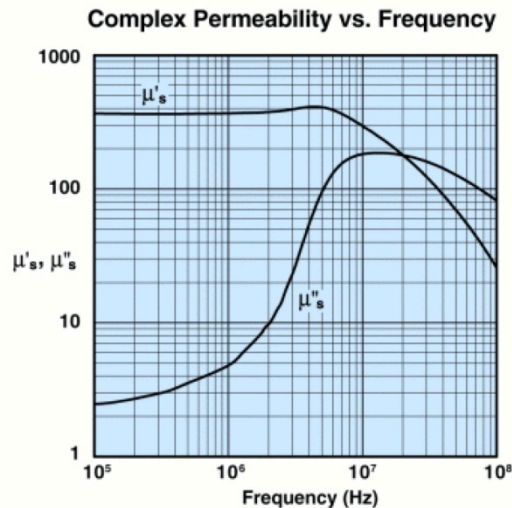

- Fair-Rite 51
 - Low-loss
 - Modest frequency response (5 MHz)
 - Not square

Ferrite

- Two dominant compositions
 - MnZn
 - Larger ΔB
 - Switch-mode power supply transformers

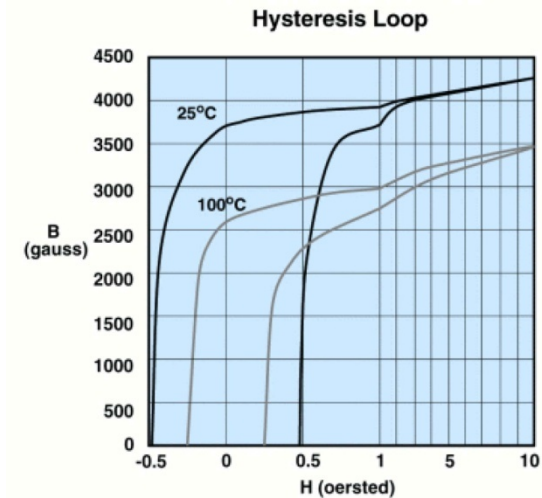
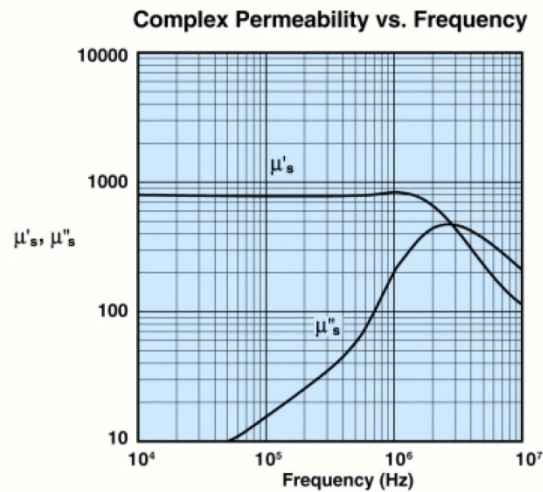

- Fair-Rite 85
 - Square loop

Tape Wound Core Materials

- Crystalline
 - Traditional core material
 - Common formulations: Si-Fe and Ni-Fe
 - Lowest cost
 - Poorest high frequency performance
- Amorphous (Metglas ©)
 - Developed in 70's/80's
 - Iron-based, Ni-Fe-based, and cobalt-based formulations
 - Low loss
 - Higher frequency response
 - Magnetic properties very dependent on annealing
 - Higher costs
- Nano-crystalline
 - Iron-based
 - Similar magnetic properties to Metglas
 - Zero magnetostriction

Crystalline Materials

- Si-Fe
 - $\Delta B > 3 \text{ T}$
 - $\mu_{\text{max}} > 25,000$
 - Low frequency applications, 1 – 16 mil thickness
- Ni-Fe
 - $\Delta B \sim 1.5 \text{ T}$
 - $\mu_{\text{max}} > 25,000$ (>100,000 grain oriented material)
 - Thin material, <1 mil, good at higher frequencies, but expensive

Amorphous Materials

- 2605 SA1
 - Most common Fe-based material
 - Modest high frequency response
 - Lowest cost of the amorphous materials
 - $\Delta B \sim 3 \text{ T}$
 - $\mu_{\text{max}} > 100,000$

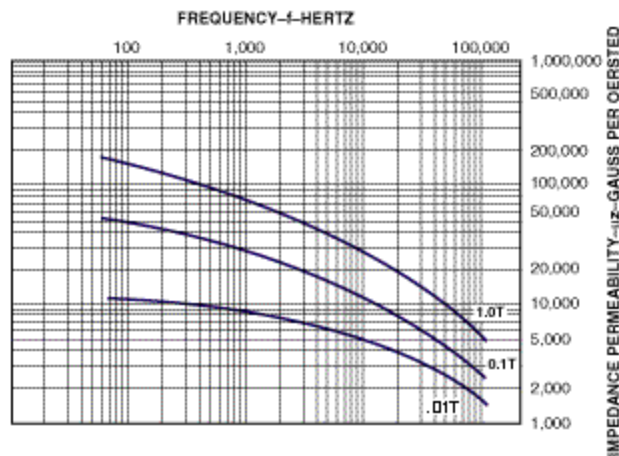

Typical impedance permeability curves
Longitudinal field anneal

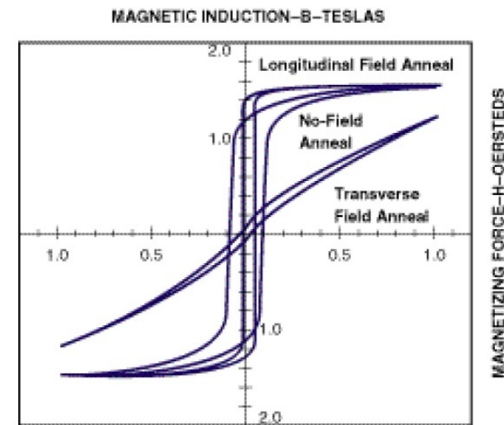

Typical dc hysteresis loops

Amorphous Materials

- 2605CO
 - Fe-based, with cobalt
 - Exceptionally square loop with longitudinal field annealing (lost tech ?)
 - Best material available for high frequency magnetic switching (0.7-mil)
 - $\Delta B = 3.3 \text{ T}$
 - $\mu_{\text{max}} \sim 100,000$ (dc)
 - $\mu_{\text{max}} \sim 6,000$ (1 μs saturation)
 - $\mu_{\text{max}} \sim 1,000$ (0.1 μs saturation)
- 2714A
 - Co-based
 - Very square, very low loss
 - Best high frequency characteristics
 - $\Delta B = 1 \text{ T}$
 - $\mu_{\text{max}} \sim 500,000$ (dc)



Nano-crystalline Materials

- Similar high frequency permeability and squareness as 2605CO
- $\Delta B \sim 2 \text{ T}$
- $\mu_{\text{max}} \sim 60,000 \text{ (dc)}$
- Major suppliers
 - Hitachi “Finemet”
 - Vacuumschmelze
 - “Russian”
- Hitachi makes excellent cores (including toroids)
 - Well annealed
 - Well constructed (ceramic insulation)



Passive Components and Devices

- Resistors
- Capacitors
- Inductors
- Transformers
- Transmission lines
- Loads
 - Klystrons
 - Beam kickers

Resistors

- Resistor behavior

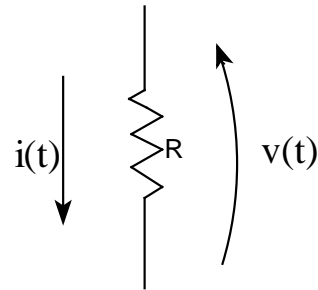

$$v(t) = Ri(t)$$

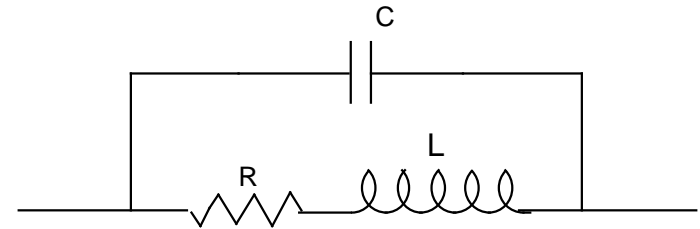

High-Frequency Equivalent Circuit

Resistor Types

- Film
 - Commonly available
 - Inexpensive
 - Low active material mass → low energy capacity
 - 1W carbon film: ~3 J
 - 1W metal film: ~1 J
 - High voltage film resistors often have a helical pattern → high inductance
 - Alternative, non-inductive serpentine pattern (Caddock)
 - SMD
 - Usually trimmed with an “L-cut”, introduces inductance
 - Tend to arc (and fail) at trim, due to $V = L \, dI/dt$
- Wire wound
 - Very inductive
 - Large power types (e.g. 225 W) can support large pulsed voltages, but if maintained at high voltage dc, will corona and eventually fail



Resistor Types (cont.)

- Composition
 - Large active material mass → large energy handling capacity
 - Carbon Composition
 - 2W “standard” no longer manufactured
 - Voltage and power capacity varies by value
 - 2W: ~80 J, >2 kV repetitive, ~10 kV non-repetitive
 - Ceramic Composition
 - Ohmite OX/OY
 - Even better than carbon comps
 - 2W: ~20 kV non-repetitive
 - Bulk ceramic
 - Stackpole → US Resistor → Kanthal Globalbar / Carborundum → Cesewid → Kanthal Globalbar, but also Asian and European manufacturers
 - Vary composition for high voltage, high average power, and high peak power
 - Special coatings for immersion in oil (prevents resistance change)
 - Terminal shape and application critical for long life (corona prevention)
 - Increase average power capacity, ~7X, by flowing water through bore

Resistor Types (cont.)

- Water resistors
 - Typically constructed with insulating tubing (plastic, flexible or rigid, or glass) envelope which contains water with electrodes at each end
 - May be sealed, resistance usually not very stable, or recirculating which can be accurately adjusted
 - Resistivity strongly dependent on water temperature
 - “Salt” is added to provide carriers
 - CuSO_4
 - Borax, environmentally benign
 - NaCl
 - KCl
 - Current density on electrodes limited by carrier density (solubility limits)
 - Exceeding j_{critical} (740 mA/cm^2 for CuSO_4) \rightarrow electrode erosion and/or electrolysis
 - Large specific energy deposition \rightarrow heating \rightarrow shock wave
- Beam sticks
 - High power but high cost

Capacitors

- Capacitor behavior

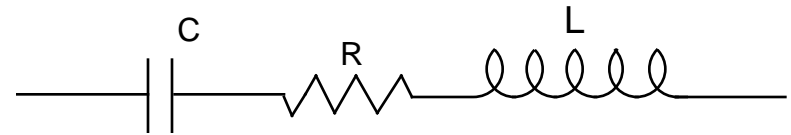
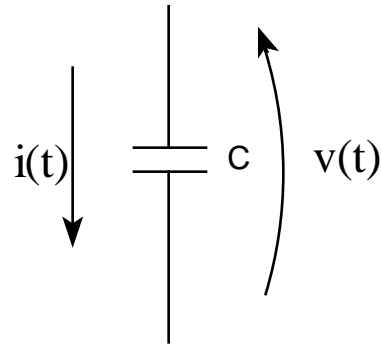

High-Frequency Equivalent Circuit

ESR \equiv parasitic resistance

ESL \equiv parasitic inductance

DF \equiv dissipation factor = $R\omega C$

$$q = CV$$

$$i(t) = C \frac{dV(t)}{dt} \quad : \quad \langle i \rangle = C \frac{\Delta V}{\Delta t}$$

$$V = \frac{1}{C} \int i(t) dt$$

Capacitor Types

- Coaxial cable
 - Often acts as capacitor unintentionally
 - $C = \tau/Z$ (transit time/impedance)
- Electrolytics
 - Lossy above ~kHz
 - Limited use in pulsed power, except slow circuits
- Mica
 - High quality
 - Stable
 - Low loss
 - Energy density: $\sim 0.01 \text{ J/cm}^3$
 - Limited distribution, usually made to order
- Water
 - High energy density
 - Due to limited resistivity, only useful in short pulse applications
 - Not commercially available

Capacitor Types (cont.)

- Ceramic
 - Available to 50 kV
 - High average current types are available
 - Energy density $\sim 0.025 \text{ J/cm}^3$
 - Lifetime: ?
 - Capacitance varies with voltage and temperature
 - Stability characterized by “class”
 - I, NPO, COG: most stable
 - II, X7R, Y5P: more variation
 - III: capacitance may decrease 50% at rated voltage

Film Capacitors

- Most commonly used capacitor type for pulsed power applications
- Parameters
 - Voltage: to 100 kV (typically)
 - Current: to 0.25 MA
 - Lifetime: function of
 - Dielectric voltage stress: life $\propto E^x$, typically $5 < x < 9$
 - Temperature: life is halved for every 10° C increase (polypropylene)
 - Voltage reversal (pulse discharge): dV/dt relative to dielectric relaxation time
- Construction
 - Dielectric materials
 - Paper (wicks “oil”)
 - Polymers
 - Polyester (Mylar®)
 - Polypropylene, High Crystalline Polypropylene (HCPP) best
 - Hazy films wick “oil”
 - Oil/fluid (see page 9&10)
 - Combinations of the above

Film Capacitors (cont.)

- Construction (cont.)
 - Conductors
 - Foil
 - Aluminum typical
 - High currents
 - Extended foil (instead of tabs) designs for very high current
 - Metalization of dielectric films
 - Lower cost
 - Decrease volume
 - Can be made “self-healing”, defects in <2% of film
 - » Internal breakdown in film ablates metalization: isolates defect
 - » Breakdown energy controlled by controlling metalization
 - Pattern
 - High resistivity metalization, to 0.2 kΩ/□
 - Fabrication
 - Wind (precision winding machines) on mandrel, annular
 - Flatten
 - Interconnect: series/parallel sections, usually <10 kV/section
 - Package
 - Impregnate



Film Capacitors (cont.)

- Film/Foil construction
 - Standard for HV pulse discharge caps
 - Energy density:
 - $\sim 0.02 \text{ J/cm}^3$, typical
 - To $\sim 1 \text{ J/cm}^3$, for high energy density applications (short life)
 - Life
 - Scales as V^7 for a given design
 - >20 year or 10^{10} pulses possible, 10^4 to 10^5 more typical for high power caps
- Metalized film construction
 - Higher ESR
 - Lower current capacity
 - Metalization pattern can be tailored to increase current capacity
 - Can be combined with foil to increase current capacity
 - Energy density:
 - 0.1 to 0.3 J/cm^3 , typical
 - Life
 - Scales as V^9 for a given design
 - >20 year or 10^{10} pulses possible



Component Websites

- Capacitors
 - NWL: <http://www.nwl.com>
 - Illinois Capacitor: <http://www.illcap.com/>
 - Cornell-Dubilier: <http://www.cornell-dubilier.com/film.htm>
 - Dearborn: <http://www.dei2000.com/>
 - Seacor: <http://www.seacorinc.com/>
 - Electronic Concepts: <http://www.ecicaps.com/>
 - Novacap: <http://www.novacap.com/index.html>
 - CSI: <http://www.csicapacitors.com/index.asp>
 - GA/Maxwell: <http://www.maxwellcapacitors.com/>
 - WIMA: http://www.wima.com/en_index.php
- Resistors
 - EBG Resistors: <http://www.ebgusa.com/>
 - RCD Components: <http://www.rcdcomp.com>
 - HVR Advanced Power Components: <http://www.hvrapc.com>
 - International Resistive Co. <http://www.irctt.com>
 - Kanthal Global: <http://www.global.com>
 - Caddock Resistors: <http://www.caddock.com>

Inductors

- Inductor behavior

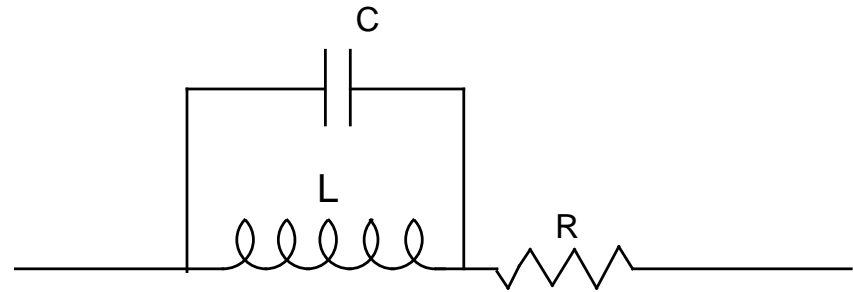
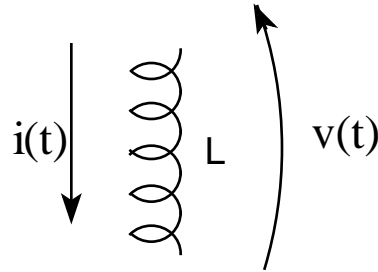

High-Frequency Equivalent Circuit

$$V(t) = L \frac{di(t)}{dt} \quad : \quad \langle V \rangle = L \frac{\Delta i}{\Delta t}$$

$$i(t) = \frac{1}{L} \int V(t) dt$$

Inductor Types

- Coaxial cable
 - Often acts as inductor unintentionally
 - $L = \tau Z$ (transit time • impedance)

- Current loop

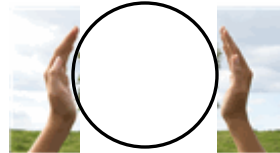

- $10 \mu\text{H} =$
- $L = N^2 (a/100) [7.353 \log(16a/d) - 6.386]$ (μH)
 - N turns
 - On radius of a (inch)
 - Of d (inch) diameter conductor, ($a/d > 2.5$)

- Toroid

- Closed field lines, minimize interaction with adjoining components

- $L = (N^2 \mu \ell / 2\pi) \ln(b/a)$ (H)

- N turns
- Toroid outer radius, b (m)
- Toroid inner radius, a (m)
- Toroid length/thickness, ℓ (m)

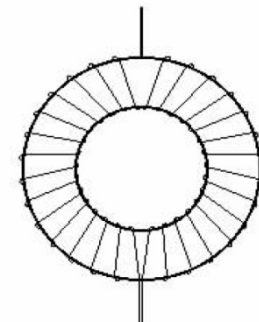
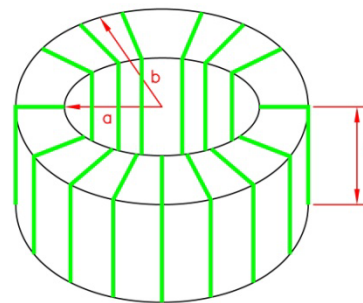

DOUBLE ENDED TORUS

- Double ended for HV

Inductor Types

- Solenoid
 - Ideal: $L = N^2 \mu \pi r^2 / \ell$ (SI)
 - Typical: $L = N^2 [r^2 / (9r + 10\ell)]$ (μH)
 - Generally: $L = F N^2 d$ (μH)
 - Single-layer solenoid
 - N turns
 - Radius: r
 - Diameter: d
 - Length: ℓ

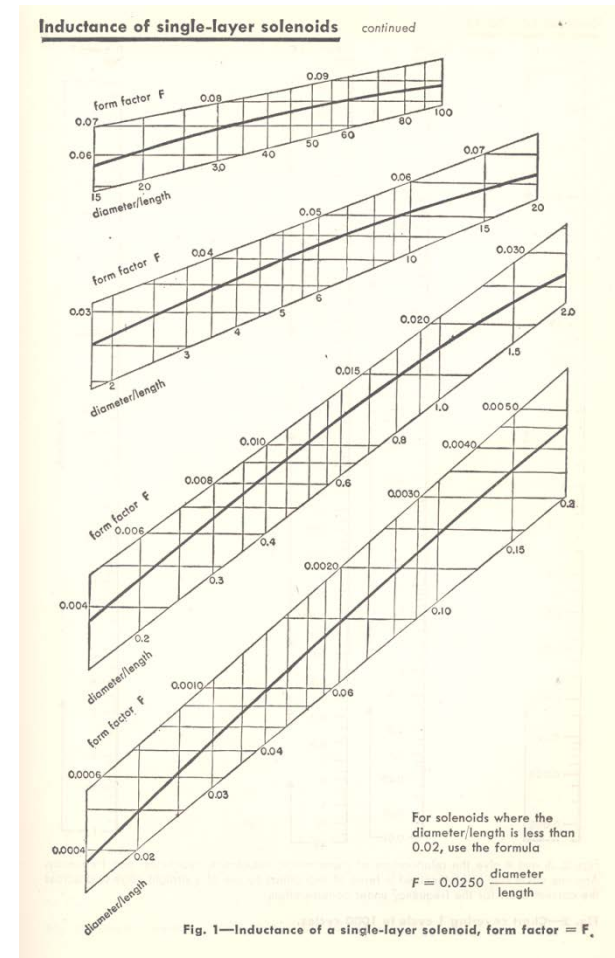

Inductors

- Permeability
 - Air core: μ_0
 - Constant, independent of frequency and current (subject to parasitic effects)
 - Low permeability
 - “Cored” (i.e. filled with magnetic material)
 - $V\tau$ constraint
 - $\mu = f(\omega, I)$
 - μ_r as high as $>10^5$
 - Compromise: gapped core
- Quality factor
 - $Q = \omega L / \text{ESR}$
 - Energy loss per cycle / total stored energy
- Commercial inductors are generally made “to order”
 - Magna Stangenes (Stangenes Industries)

Transformers

Transformer model

Equivalent
Circuit

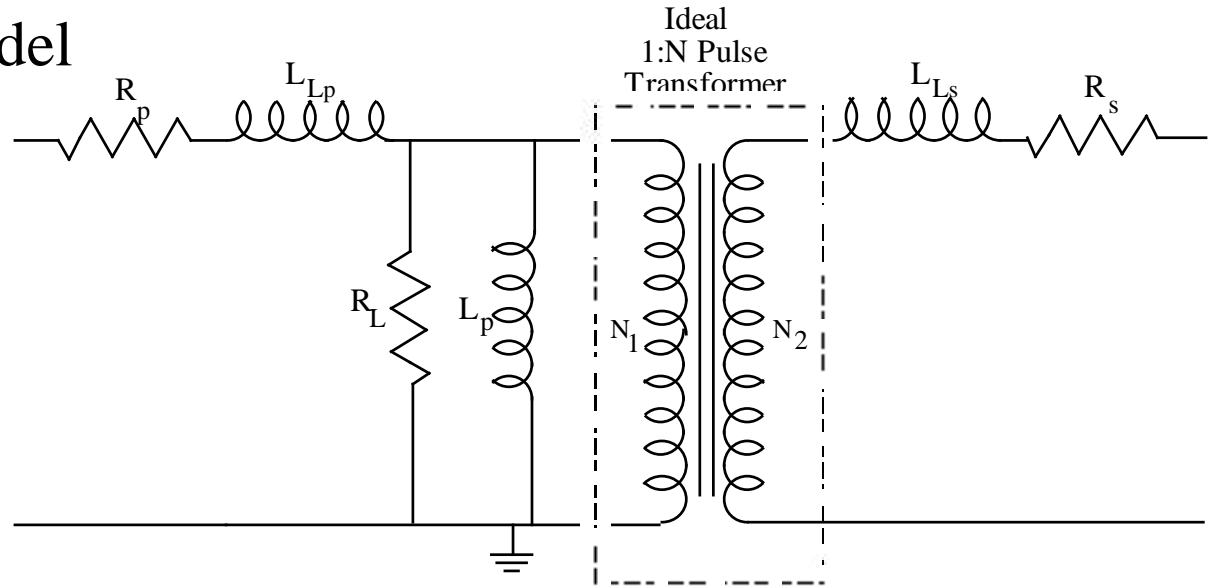

Where:

R_p = resistance of primary winding

R_s = resistance of secondary winding

R_L = magnetic core loss

L_p = inductance of primary winding (measured with secondary winding open)

L_s = inductance of secondary winding (measured with primary winding open)

L_{Lp} = leakage inductance of primary winding (measured with secondary shorted)

L_{Ls} = leakage inductance of secondary winding (measured with primary shorted)

leakage inductance is due to flux not linked by both primary and secondary windings

$N_1:N_2 = 1:N =$ turns ratio of ideal transformer

Transformers

- Transformer model (cont.)

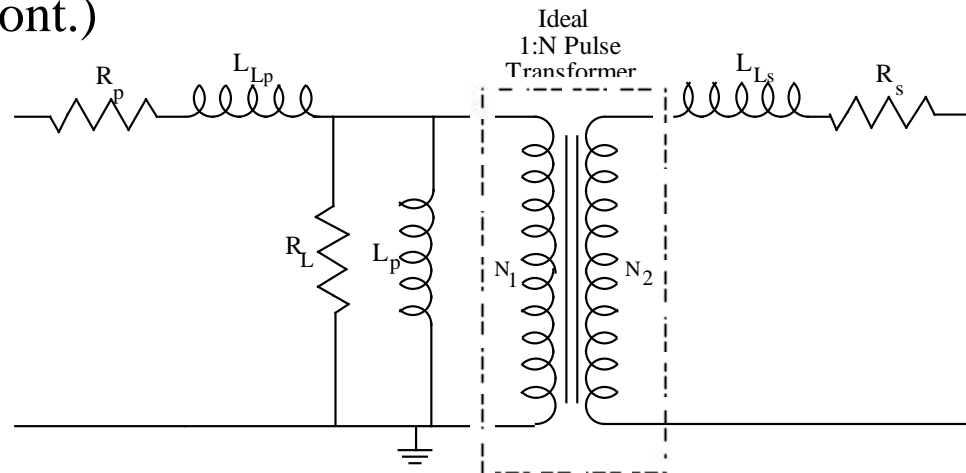

$$\text{Primary Circuit Load} = \frac{Z_{\text{secondary}}}{N^2}$$

$$V_{\text{secondary}} = NV_{\text{primary}}$$

Other parameters:

k = coefficient of coupling between primary and secondary inductors

M = mutual inductance between two inductors

$$M = k\sqrt{(L_p L_s)}$$

$$L_{Lp} = (1 - k)L_p$$

$$L_{Ls} = (1 - k)L_s$$

Pulse Transformers

- Functions
 - Voltage gain
 - Impedance matching
 - Teach humility
- Core
 - Material limitations
 - $V\tau$ constraint
 - $\mu = f(\omega, I)$
 - Typically gapped
- Stray capacitance
 - Primary to secondary
 - In series with leakage inductance
 - Operate below self-resonance
 - Secondary inter-winding
 - Load secondary
- Commercial pulse transformers are generally made to order

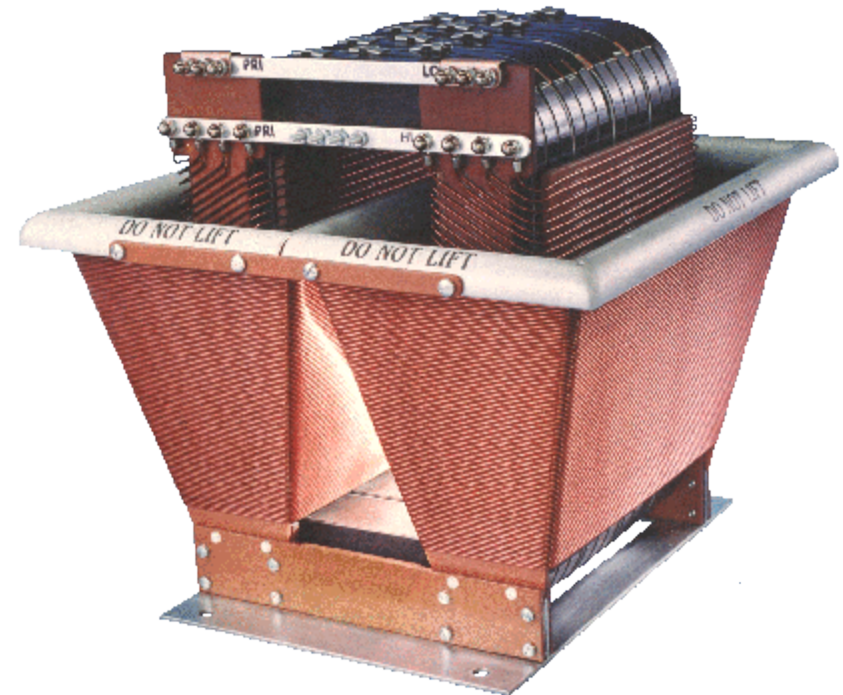

Stangenes Industries klystron transformer

Inductive Adder Transformer Design Example

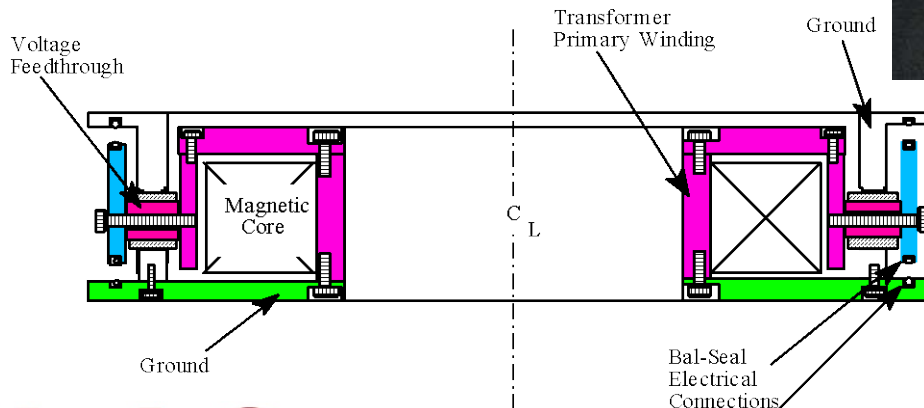

Inductive Adder Transformer Design Example

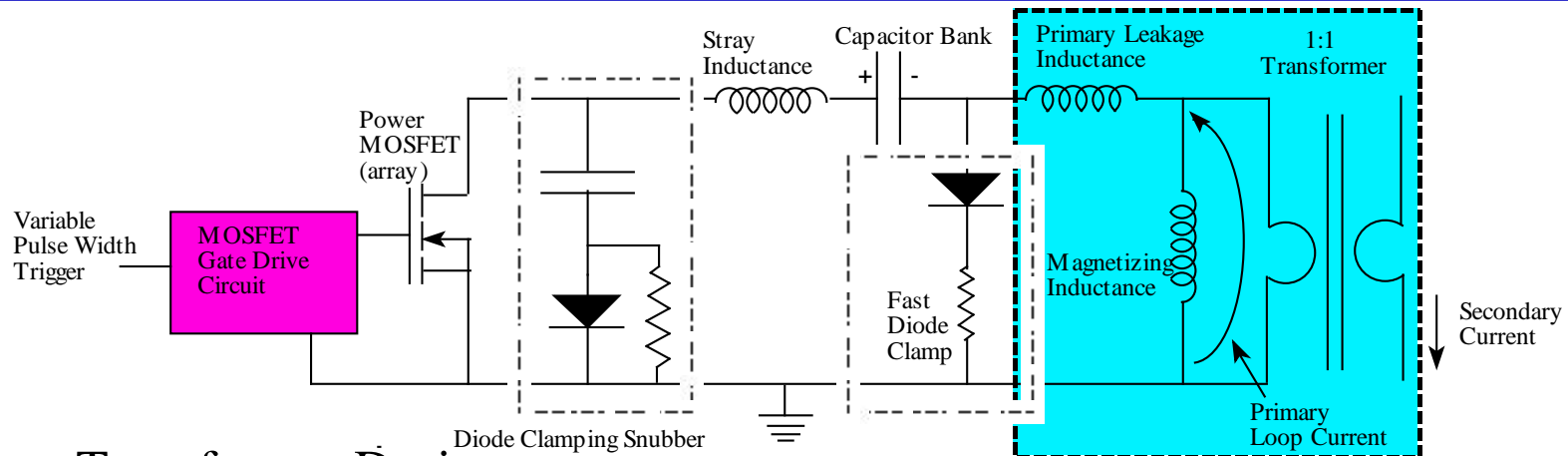

- Transformer Design

- Select transformer geometry

- Want a very high coefficient of coupling between primary and secondary
 - Single turn primary that totally encloses magnetic core

- Select magnetic core material

- Want low magnetizing current and leakage inductance so μ_r must be large
- Magnetic core should never saturate during burst (use large safety factor)
- Selected annealed MetGlass™ 2605-S3A
 - pulsed $\mu_r \sim 8000$
 - $\Delta B > B_{SAT}$ to $-B_r \sim 2.8$ T; use 0.5 T w/o interpulse reset
 - $\Delta\tau = 30$ ns + 30 ns + 110 ns + 130 ns = 300 ns



Inductive Adder Transformer Design Example

Pulsed BH Curve Data for Metglas™ SA1 and Nanocrystalline Magnetic Cores

BH Curve - Metglas™ SA1
11.8µs PulseWidth, 8A Reset

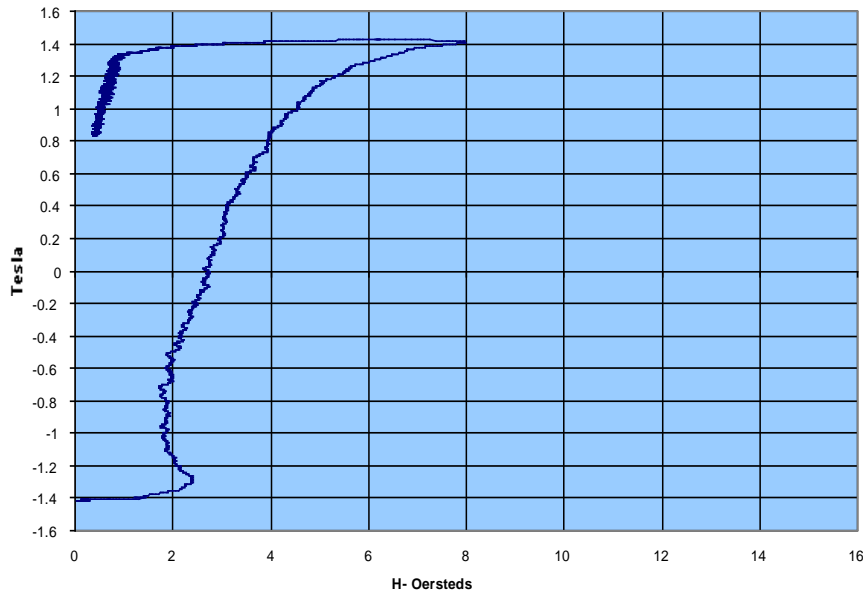

BH Curve - Nanocrystalline
7.75µs PulseWidth, 8A Reset

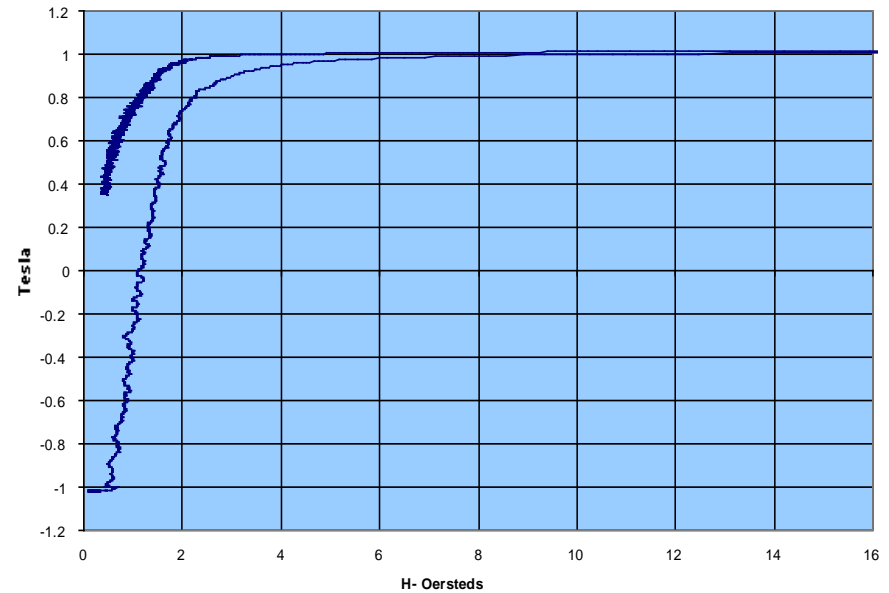

Material

V-s with reset

V-s with reset
disconnected

Metglas™ SA1

6.84×10^{-3}

6.05×10^{-3}

Nanocrystalline (longitudinal anneal)

4.89×10^{-3}

3.70×10^{-3}

Inductive Adder Transformer Design Example

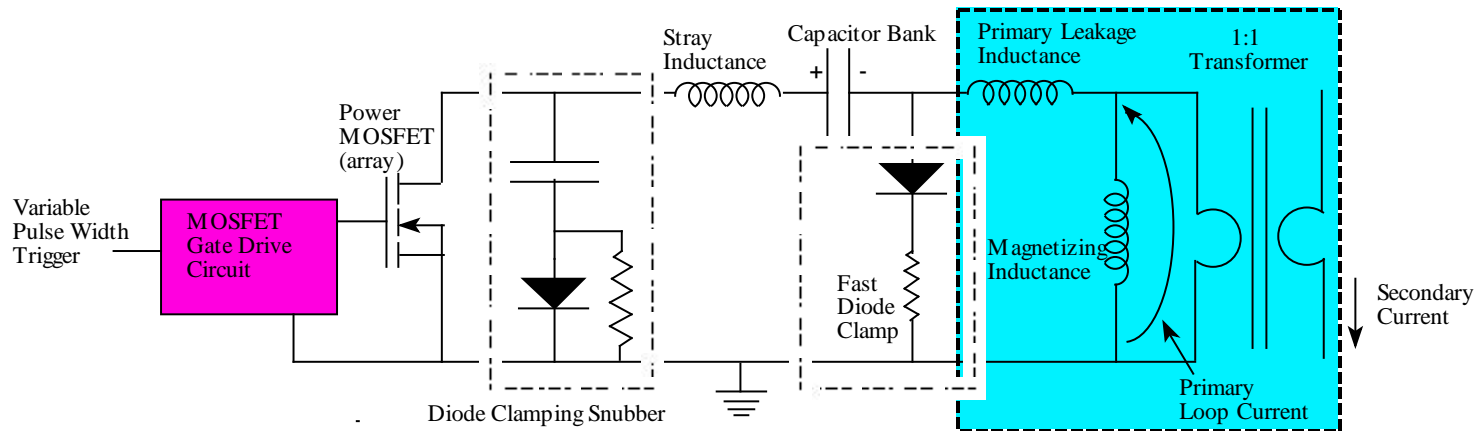

$$\Delta \tau = \frac{N A_m \Delta B}{V_{avg}} = \frac{N A_m \Delta B}{\langle V \rangle}$$

$$A_m = \frac{300ns}{0.5T} 720V = 4.3 \times 10^{-4} m^2$$

$$A_m = A_c (PF)$$

$$A_c \approx 6.2 \times 10^{-4} m^2 \quad \text{for } PF \sim .7$$

Where:

A_m is cross-section area of the magnetic core

A_c is cross-section area of total core

PF is core packing factor

V_{avg} is the average voltage across the transformer primary winding

ΔB is the total available flux swing in the magnetic core

$\Delta \tau$ is the required hold-off time for the magnetic core

N is the number of turns on the primary

Inductive Adder Transformer Design Example

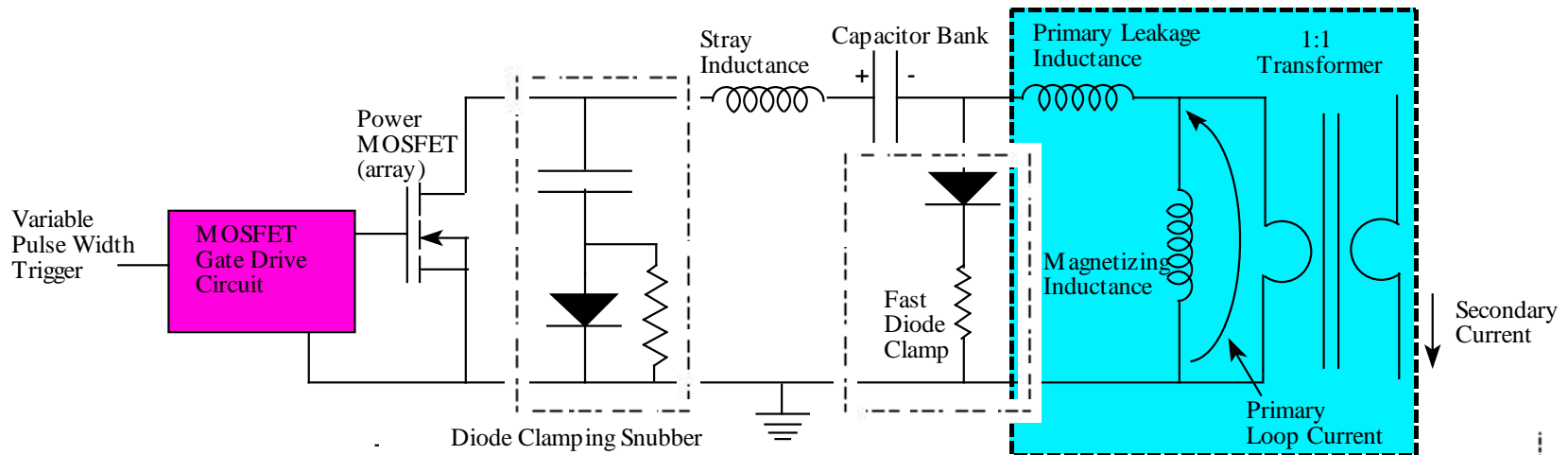

- Saturated inductance

$$L_{SAT} \sim 200 nH / m \left(\frac{1.1m}{39.4} \right) \boxed{n} \frac{7.14}{4.45}$$

$$L_{SAT} = 2.65 nH$$

- Magnetization Current

$$H_c \sim \frac{100A}{m} = \frac{I_m}{l_m} \quad @ \frac{\Delta B}{\Delta \tau} \sim 2T / \mu s$$

$$I_m \sim \frac{100A}{m} (.36m) \sim 36A$$

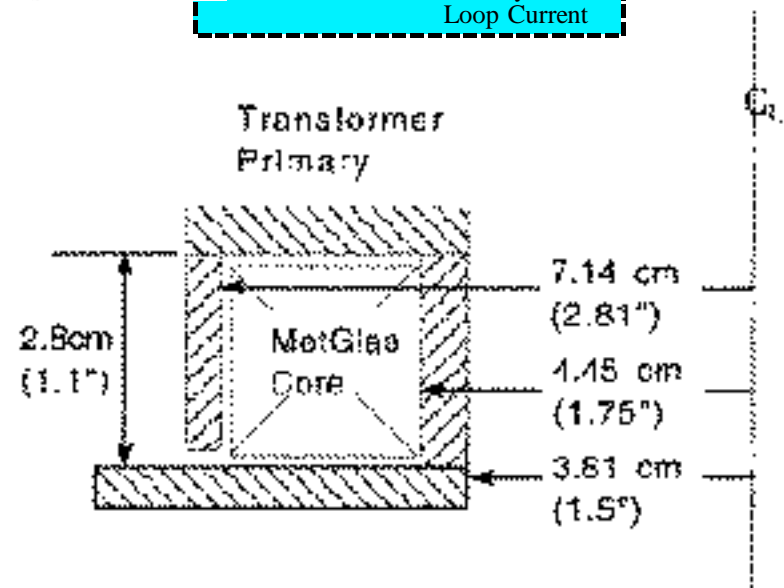

l_m = Mean Magnetic Length = 0.36 meters

Common Transmission Line Geometries

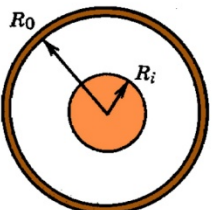
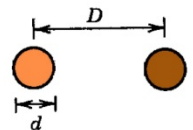
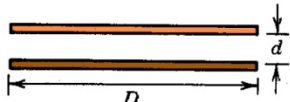
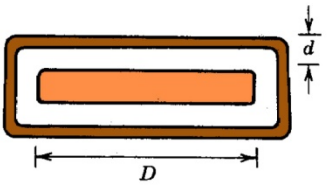
TABLE 9.3 Properties of Common Transmission Lines, TEM Modes ^a	
1 Coaxial transmission line:	 $\mathcal{C} = 2\pi\epsilon/\ln(R_o/R_i)$ $\mathcal{L} = (\mu/2\pi)\ln(R_o/R_i)$ $Z_0 = (\sqrt{\mu/\epsilon}/2\pi)\ln(R_o/R_i)$
2 Two-wire transmission line	 $\mathcal{C} = \pi\epsilon/\cosh^{-1}(D/d)$ $\mathcal{L} = \mu/\pi \cosh^{-1}(D/d)$ $Z_0 = (\sqrt{\mu/\epsilon}/\pi)\cosh^{-1}(D/d)$
3 Isolated parallel plates ($d \ll D$)	 $\mathcal{C} = \epsilon D/d$ $\mathcal{L} = \mu d/D$ $Z_0 = \sqrt{\mu/\epsilon}(d/D)$
4 Stripline ($d \ll D$)	 $\mathcal{C} = 2\epsilon D/d$ $\mathcal{L} = \mu d/2D$ $Z_0 = \sqrt{\mu/\epsilon}(d/2D)$

^a \mathcal{C} = capacitance per unit length (farads/meter); \mathcal{L} = inductance per unit length (henries/meter); Z_0 = characteristic impedance (ohms).

Discrete Element Transmission Line Approximation

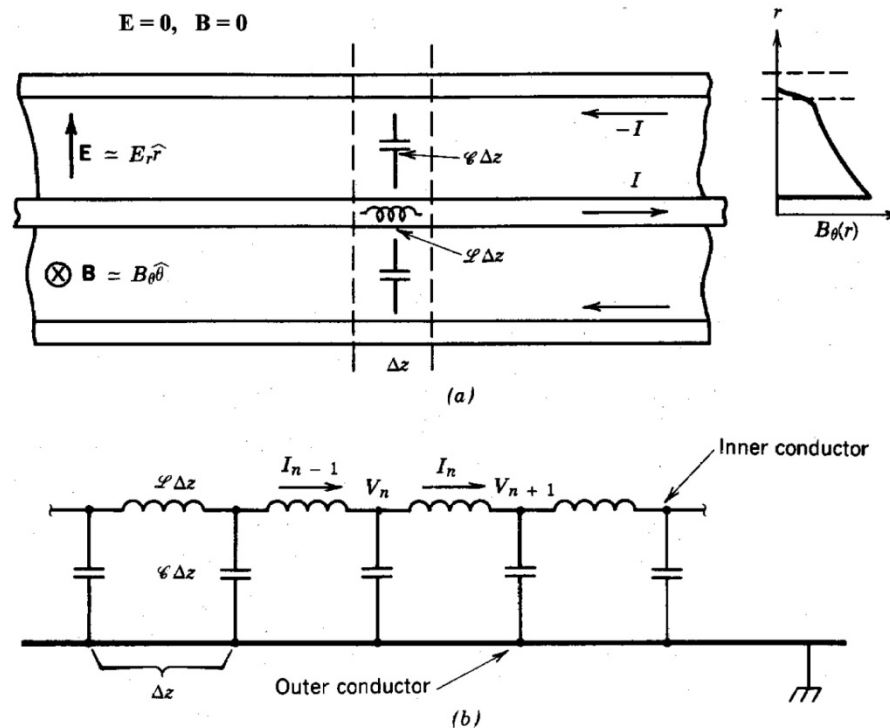

Figure 9.29 Coaxial transmission line. (a) Physical basis for lumped circuit element model of TEM wave propagation. (b) Lumped circuit element analog of a coaxial transmission line.

Transmission Line Terminations



- Matched: $R = Z_0$, $V_T = V_I$, $V_R = 0$
- Open: $R = \infty$, $V_R = V_I$, $V_T = 0$
- Short: $R = 0$, $V_R = -V_I$, $V_T = 0$
- General
 - $V_T = (2 R V_I) / (R + Z_0)$
 - $V_R = V_I [(R - Z_0) / (R + Z_0)]$
 - $I_T = (2 V_I) / (R + Z_0)$
 - $I_R = V_R / Z_0 = (V_I / Z_0) [(R - Z_0) / (R + Z_0)]$
- V_I : Incident voltage
- V_R : Reflected voltage
- V_T : Transmitted voltage
- $V_I = V_T - V_R$
- I_I : Incident current = V_I / Z_0
- I_R : Reflected current
- I_T : Transmitted current
- $I_I = I_T + I_R$

Transmission Line Termination (cont.)

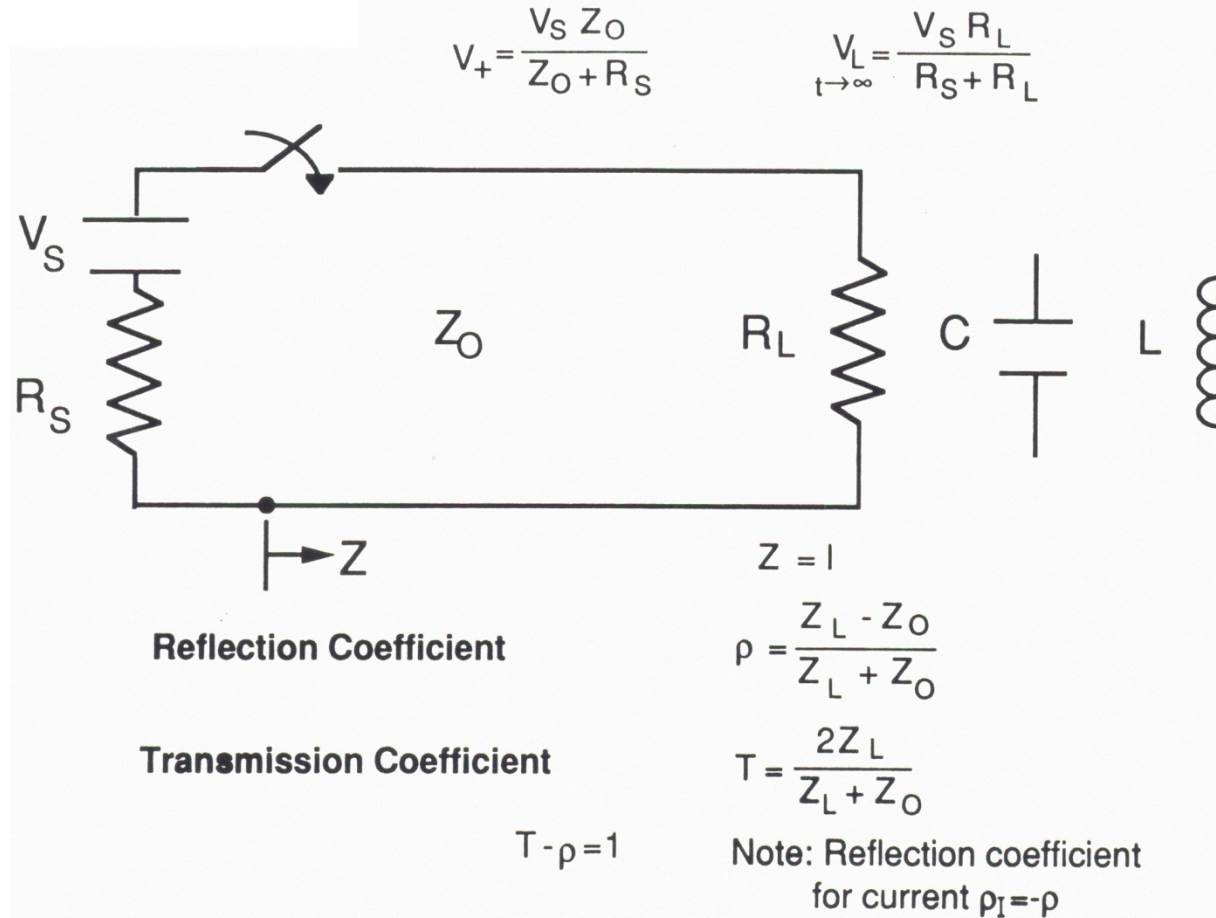

K-EMF-39

REFLECTION AND TRANSMISSION COEFFICIENTS

Transmission Line Termination (cont.)

EXAMPLE 15

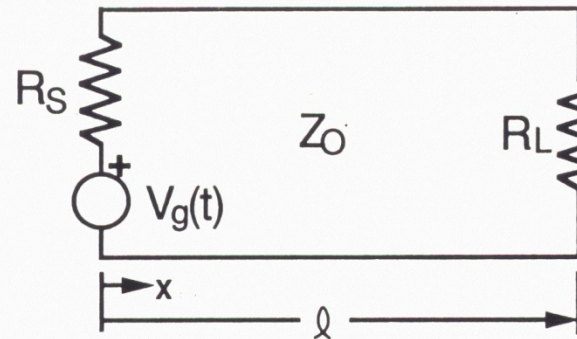
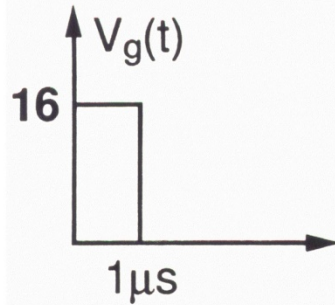

$R_S = 150\Omega$
 $Z_0 = 50\Omega$
 $R_L = 30\Omega$
 $t_{1\text{-way}} = 4\mu s$

Plot $V_{LINE}(t)$ for $0 \leq t \leq 16\mu s$ at $x = \frac{l}{2}$

$$\rho_S = \frac{150 - 50}{150 + 50} = \frac{1}{2}$$

$$\rho_L = \frac{30 - 50}{30 + 50} = -\frac{1}{4}$$

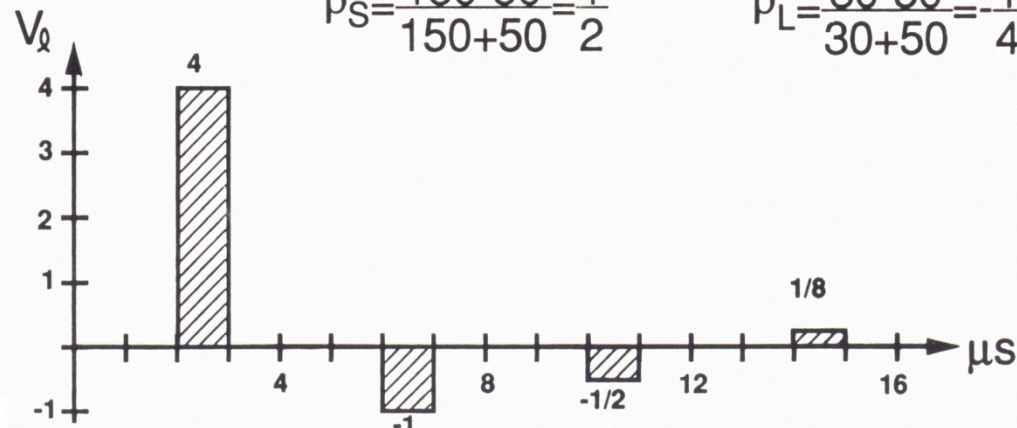

Voltage Charged Transmission Line

Charge voltage: V_o

Impedance: Z_o

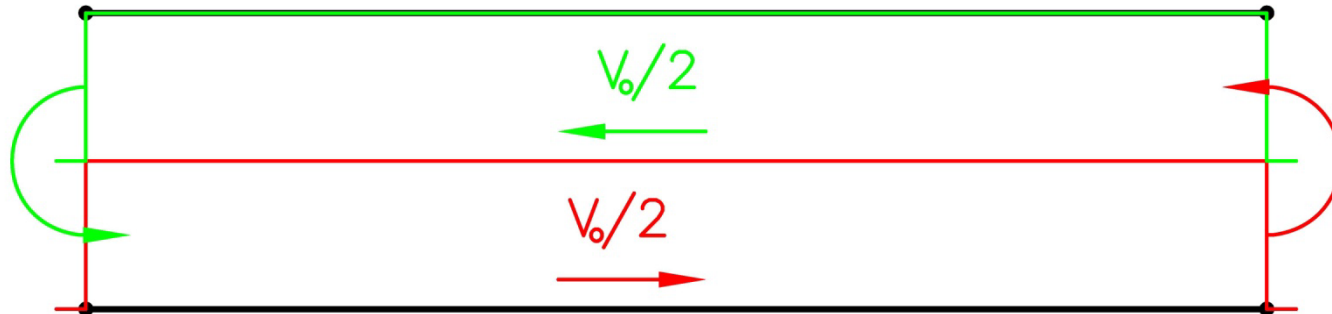

- Section of transmission charged to voltage, V_o , “open” at both ends
- Equivalent model
 - Propagating wave of voltage $V_o/2$ traveling left to right
 - Encounters open at end of line and reflects, same polarity and equal magnitude
 - Sum of left and right going waves is V_o
 - When left to right going wave reaches open at end it reflects and replenishes right to left going wave
- Implication: if line is connect to matched load, $V_T = V_I = V_o/2$

Current Charged Transmission Line

Charge current: I_0 Impedance: Z_0

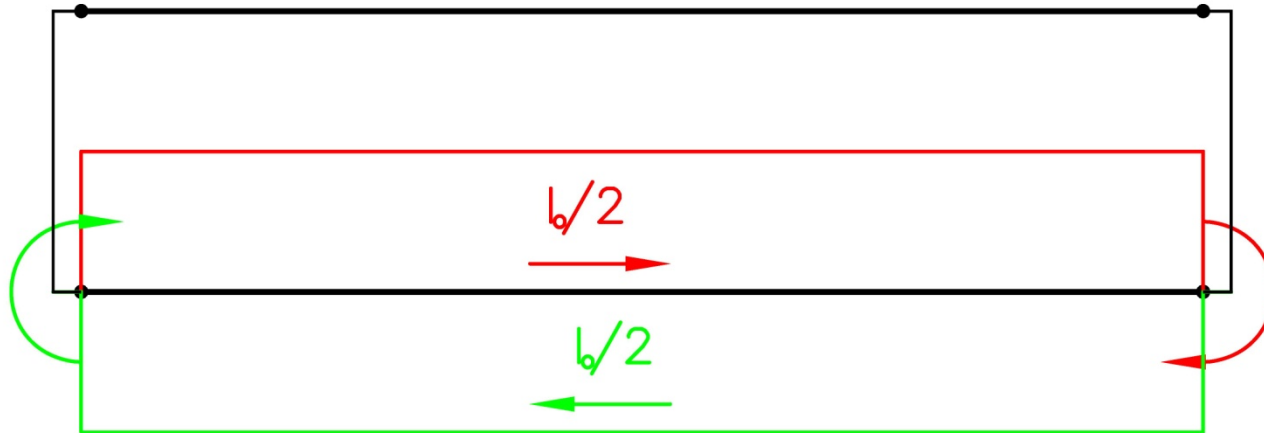

- Section of transmission charged to current, I_0 , “shorted” at both ends
- Equivalent model
 - Propagating wave of current $I_0/2$ (and voltage $I_0 Z_0/2$) traveling left to right
 - Encounters open at end of line and reflects, opposite polarity and equal magnitude
 - Sum of left and right going waves is $I = I_0$ and $V = 0$
 - When left to right going wave reaches short at end it reflects and replenishes right to left going wave
- Implication: if line is connect to matched load, $I_T = I_I = I_0/2$ and $V_T = I_0 Z_0/2$



Klystrons

- Purpose: convert low frequency electrical power to radio frequency EM power
- Capable of producing very high peak Rf power, up to ~100 MW, with a nearly constant phase and amplitude for the bulk of the output pulse
- Amplifiers: output regulation limited by input regulation
 - Low level Rf (LLRF)
 - Beam acceleration voltage
 - Rf phase α beam voltage
 - 0.1° phase stability typically required
 - Necessitates beam voltage stability to <50 V on >100 kV, 0.05% (LCLS 10 ppm)
 - Beam focusing fields (typically solenoid current)
- Electron beam devices operating with space-charge limited emission
 - $I_{\text{beam}} = \mu V^{1.5}$
 - Perveance, μ , typically $\sim 10^{-6}$
 - $Z = V/I = 1/\mu V^{0.5}$
 - $P_{\text{beam}} = VI = \mu V^{2.5} = P_{\text{Rf}}/0.6$ (typical)



Beam Kickers

- Purpose: selectively deflect a portion of a charged particle beam into an alternative transport channel
- Two general types
 - Lumped inductance
 - Kicker is an electromagnet
 - Beam deflected by magnetic field
 - High current modulator
 - Transmission line
 - Kicker presents a fixed impedance to the modulator
 - Terminated into a matched impedance to avoid reflections
 - Typically uses both E and B to deflect beam
 - No intrinsic rise/fall time, can be used in systems with small inter-bunch spacing