

Advanced Collimators for Future Colliders or Status of R&D on Collimators for e⁺e⁻ LCs & HL-LHC

12 November 2014
CAS/USPAS Joint Accelerator School
Newport Beach, CA
T. Markiewicz/SLAC

My Personal Path Into Collimation

HEP Experimentalist

- Planar Wire Chambers for Muon Beam at FNAL
- UA1 Central Drift Chamber at CERN SppS Collider
- SLD Central Drift Chamber (CDC) at SLAC

Sensitivity of CDC to HV trips and SLD Muon Backgrounds

- Machine Instabilities [Marc Ross talks] affecting beam orbit or energy causing burnt collimator coatings, muon production and massive synchrotron radiation flux in strongly focusing final quad system.

Design NLC/ILC collimation system for robustness and minimal wakes

- Tapered, coated, robust spoilers & “consumable” spoilers
- High power issues from disrupted beams after beam-beam interaction
- Muon systems

Adapt “rotatable” concept to LHC High Energy/ High Power beams

Exposed to gamut of R&D for next generation LHC collimation

- Development of robust low impedance collimators (A. Bertarelli talks)
- Hollow Electron Beams developed at FNAL
- Application of crystals to collimation

Credits and Acknowledgements

LHC Collimation & Upgrade Specification Working Groups

- R. Assmann, A. Bertarelli, S. Redaelli et al

US LHC Accelerator Research Program (LARP)

- High Power Rotatable Collimator-TWM et al at SLAC
- Hollow Electron Beam Collimation- G. Stancari et al at Fermilab

H8/UA9 Collaborations (Crystal Collimation at H8 & SPS/LHC)

- Proton Collimation: W. Scandale, D. Mirarchi, et al.

SLAC T513 Crystal Collimation Experiment

- Electron Collimation: U. Wienands et al

ILC & predecessor organizations (SLC, NLC, ..) at SLAC

- Wakefield optimized spoilers for high intensity e- beams- P.Tenenbaum
- Consumable solid and liquid metal collimators- J. Frisch et al
- Muon Spoilers-L. Keller et al

Historical Perspective SLC and SLD

In a non-circular machine cannot just wait for halo cleaning before turning detector on: experiment exposed to backgrounds on every machine cycle

Linear I on Chamber: Losses in Collimators

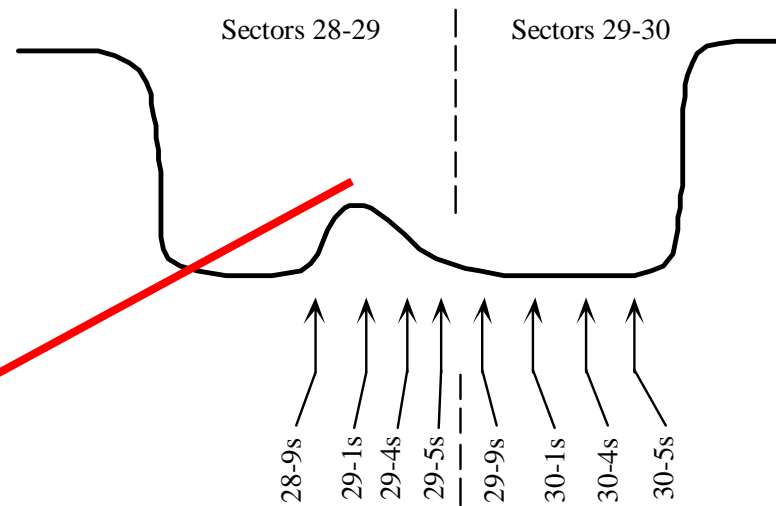

Intensity or
Spatial
Fluctuations in
Beam Loss

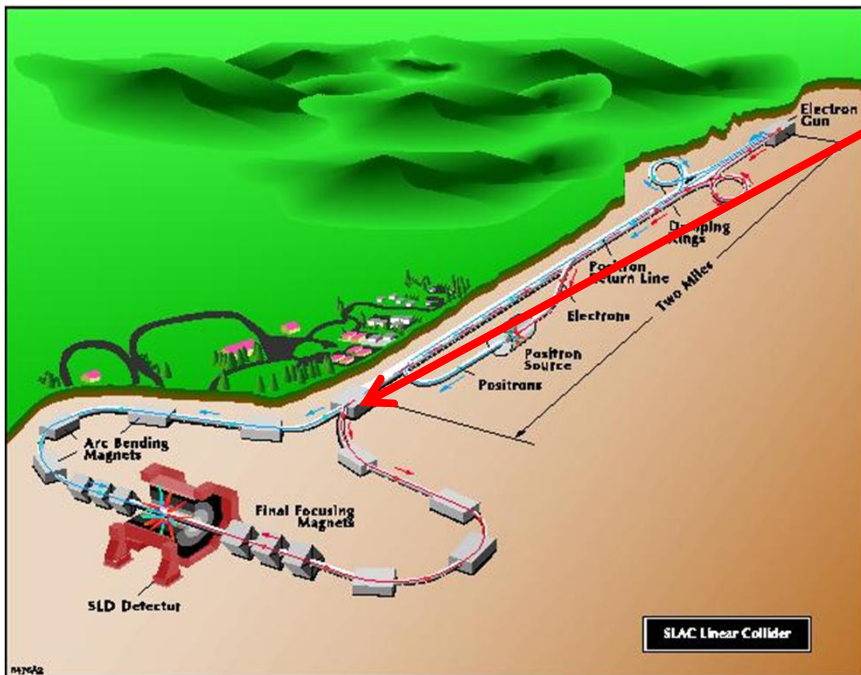
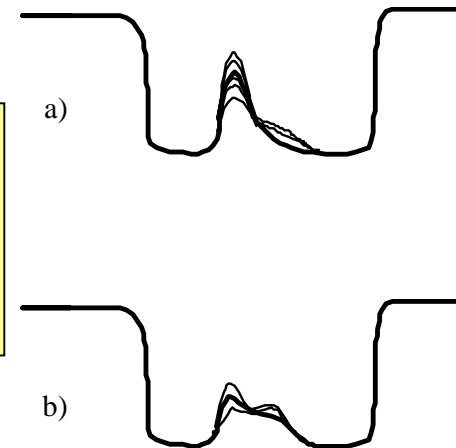

SR Fans from Halo in Final Focus Quads Could Turn Wire Tracking Chambers & CCD Vertex Detectors Black

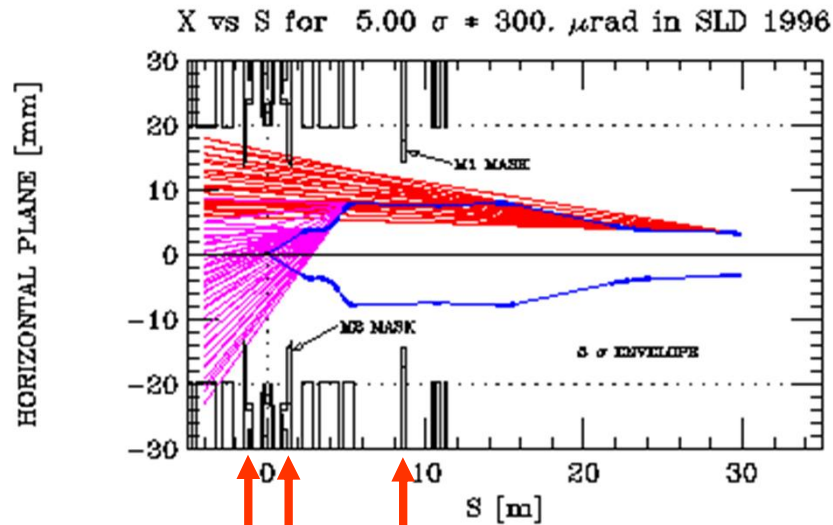

Masks

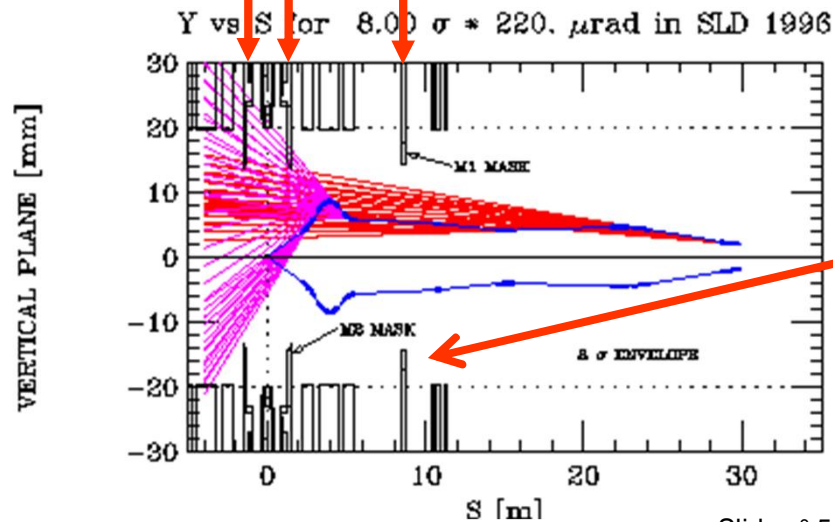

```
Run 33544, EVENT 0470
27-APR-1996 06:05
Source: Run Data Pol: R
Trigger: Energy CDC Hadron
Beam Crossing 1215252296
```

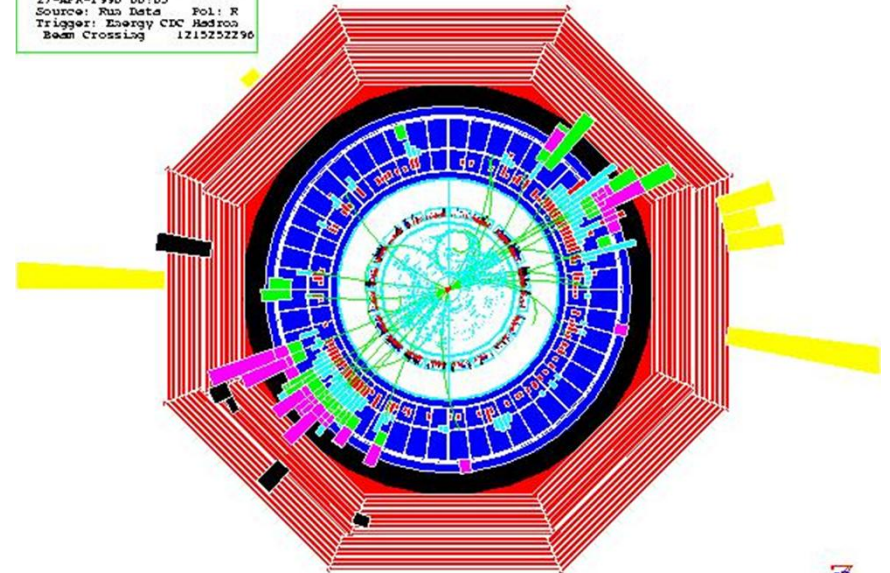

“Two Bounce” Mask System
Inadequate to Protect
Detector in Early Days

Muons from Collimators Dispersed via “Muon Toroids”

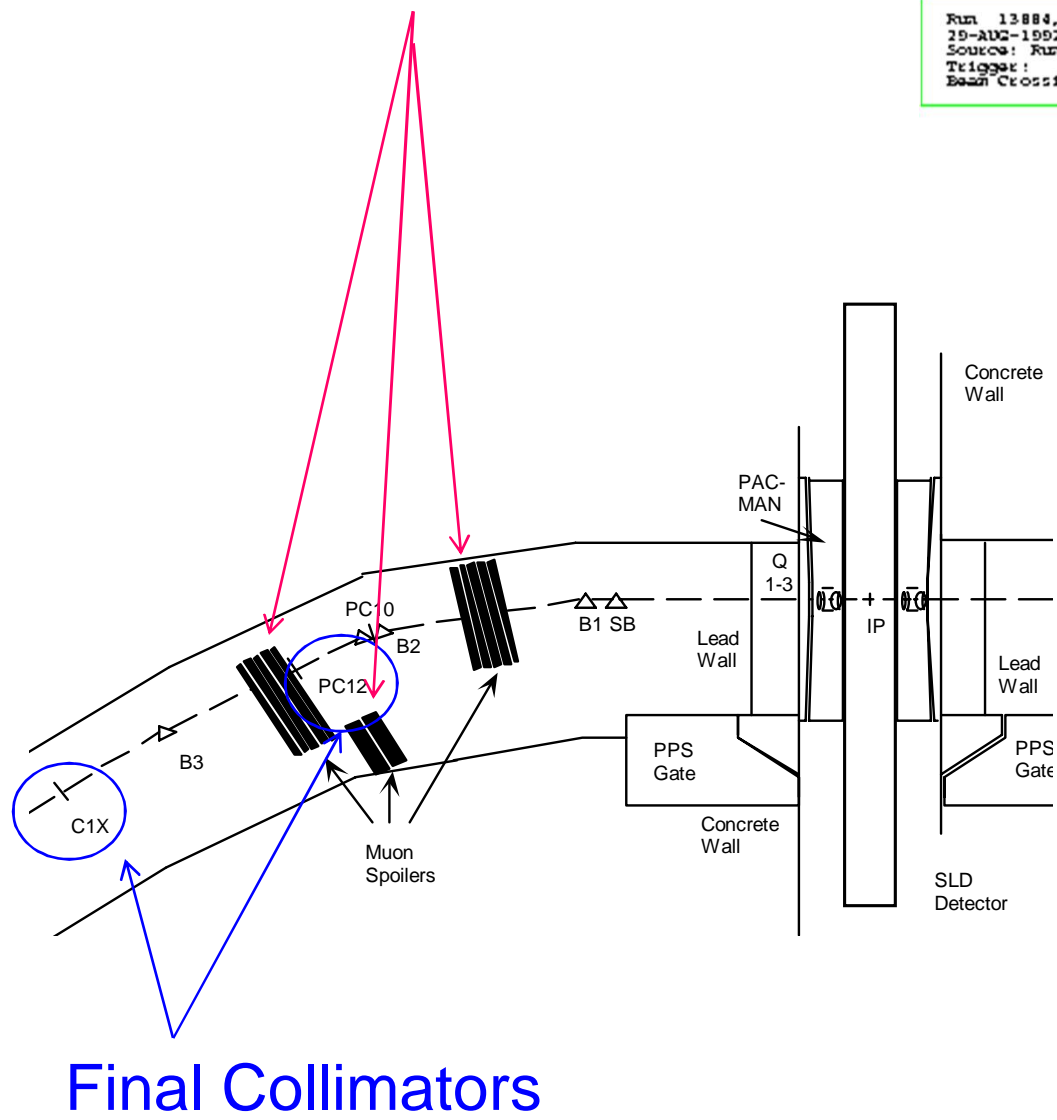

```
Run 13884, EVENT THETA=35, PHI=0
29-AUG-1992 04:43
Source: Run Data Pol: L
Trigger:
Beam Crossing -1793798240
```

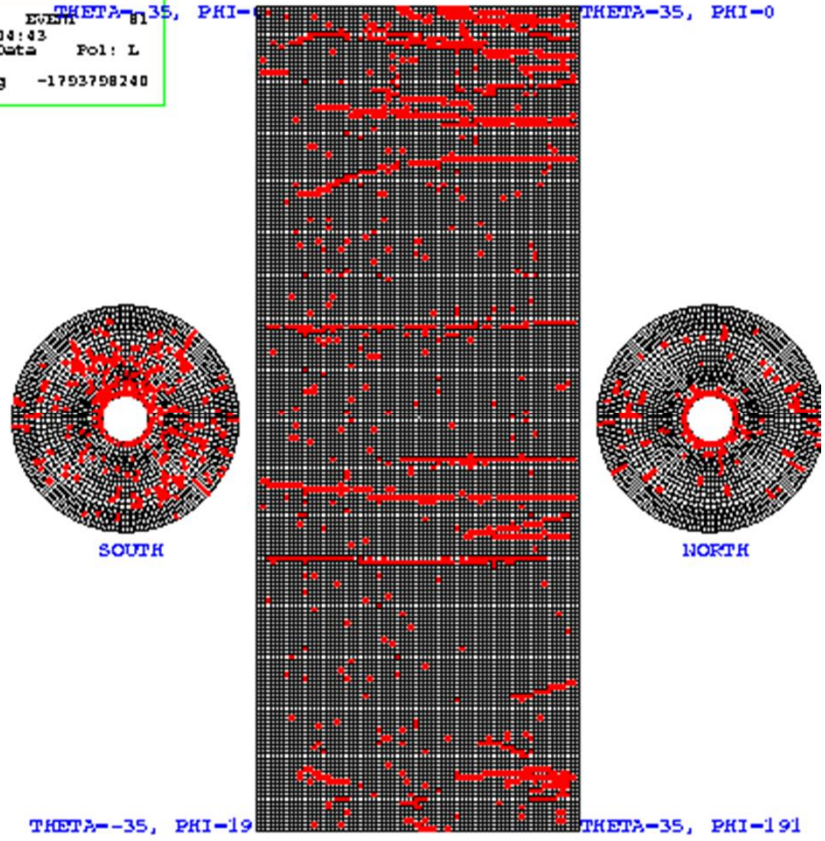

EM Calorimeters

Collimator Damage

SLC Linac Collimators in 1995: Gold-coated Titanium

↓
1mm
↑



Feature size $\sim 250\mu\text{m}$

Wakefields x25-50 larger than before damage

Cause: Image Current Heating / Dissimilar Coatings

Applying SLC Lessons Learned to NLC/ILC Designs

Collimation Apertures must be set so “**NO**” halo can make SR that hits anything in detector

- Exit aperture of calorimeter closest to beam sets this “depth”

Beam Intensity requires system of “Spoilers” and “Absorbers”

- Two stage collimation, in LHC terminology

Indestructible spoilers require very large beta functions at the spoilers which leads to position on vibration tolerances equivalent to the final focusing doublet magnets

If you don't expect many beam faults may be a good idea to build a system where collimator can be damaged a few times and still function in exchange for much looser tolerances

- Investigation of “Consumable” and “Renewable” Spoilers for NLC

Long interbunch spacing of ILC gives time to dump back part of bunch train and relaxes need for “renewable” design

Collimation Depth Set so ALL SR Exits BeamCal aperture

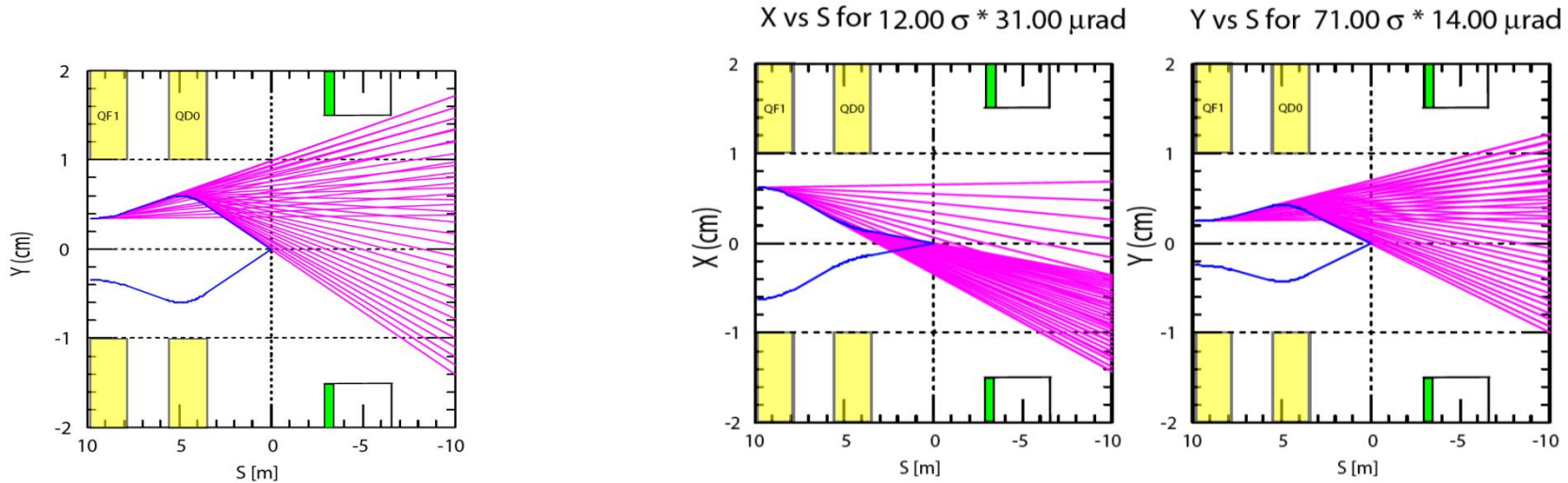

$N_x = 0$
 $N_y = 100$

$N_x = 12, N_y = 71$
 $\delta_x \sim \pm 1\text{mm}, \delta_y \sim \pm 0.5\text{mm}$

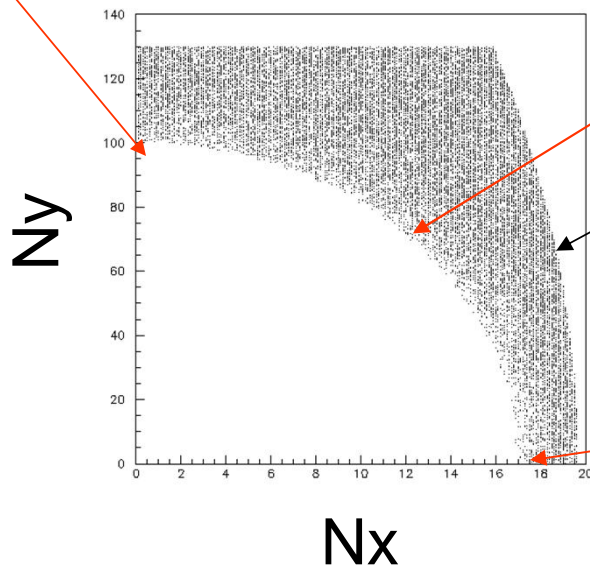

$N_x = 17$
 $N_y = 0$

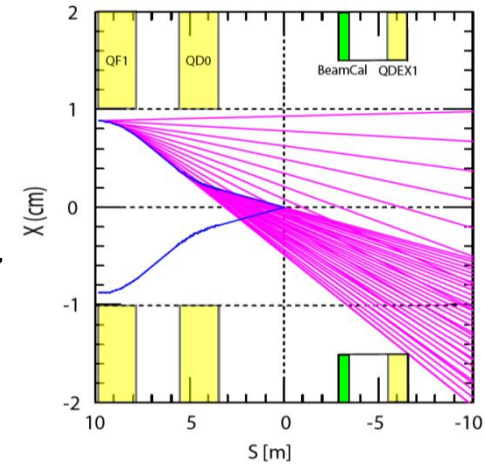

Photons per e- at Exit Aperture Increases Rapidly as Collimators Opened

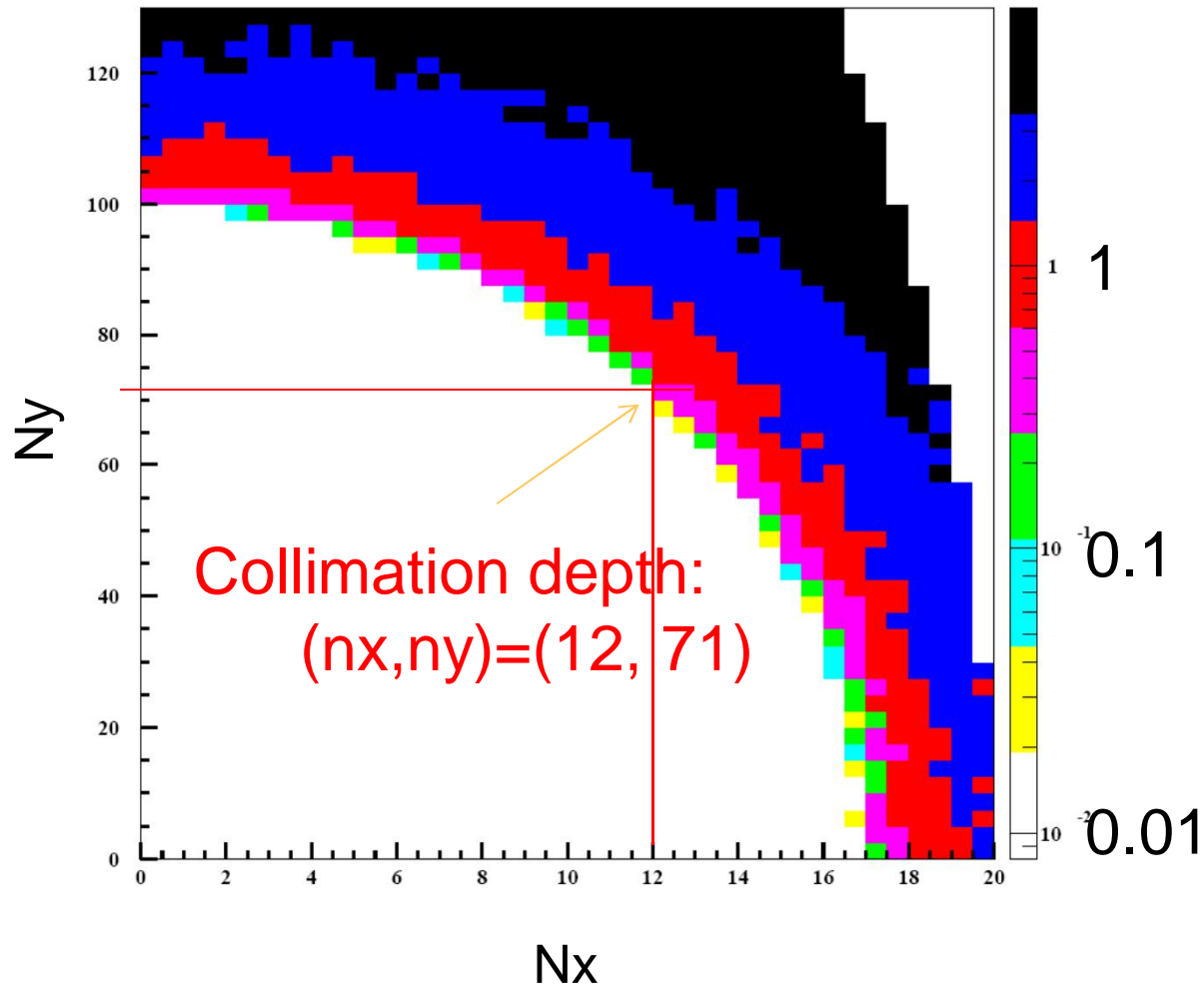

ILC Spoilers (“Primary Collimators”)

Tapered-to minimize geometric wakefields

Low resistivity surface to minimize geometric wakefields

Thin (0.6 RL) hi-Z spoiler to enhance survivability

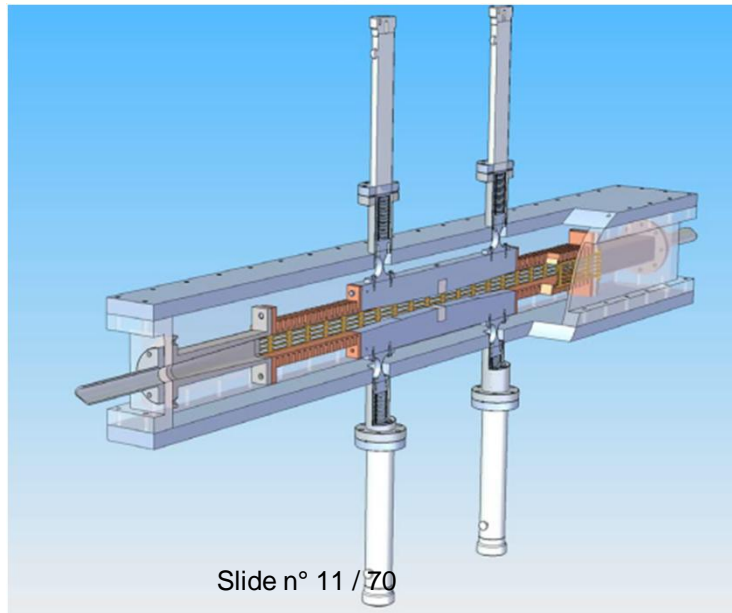
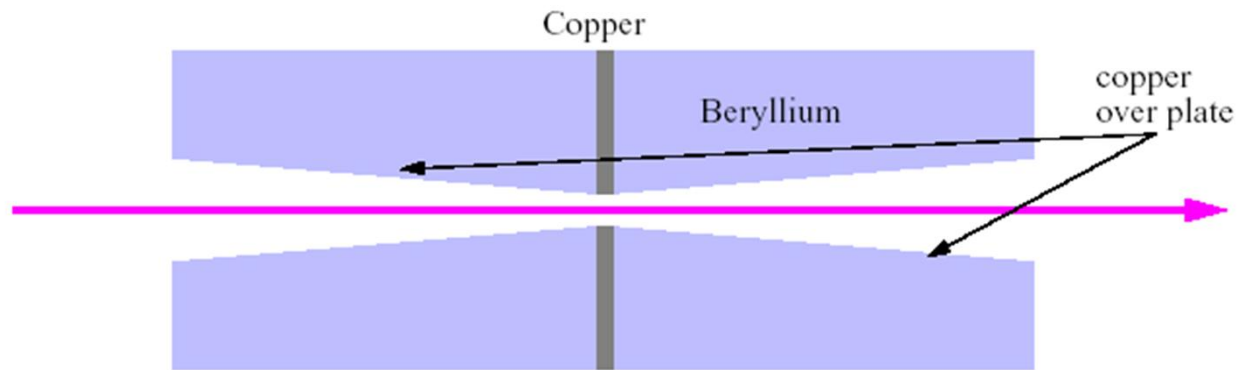

Given small gaps ($\Delta x, \Delta y \sim \pm 1\text{mm}, 0.5\text{mm}$) Beam Jitter and Emittance Growth from Collimator Wakefields a Concern:
 ~2006 Wakefield Deflection Measurements at SLAC
 Future Experiments requested for CLIC

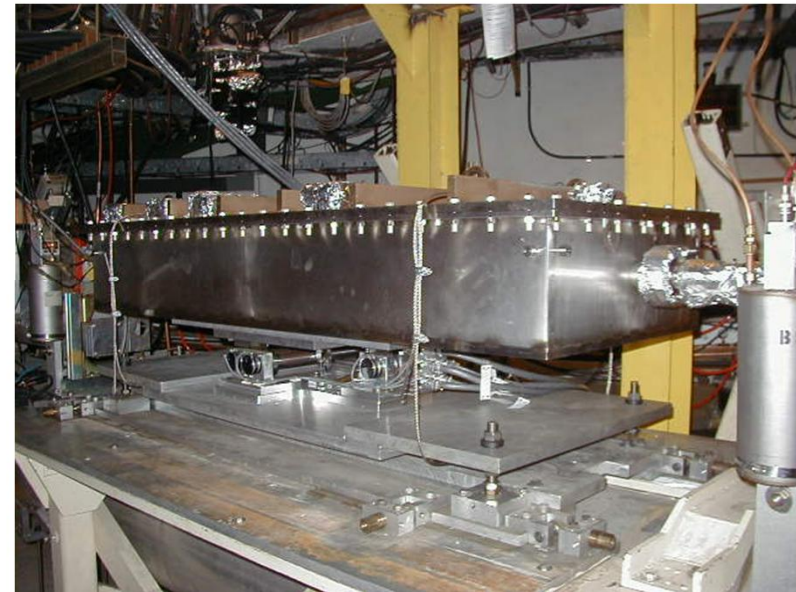
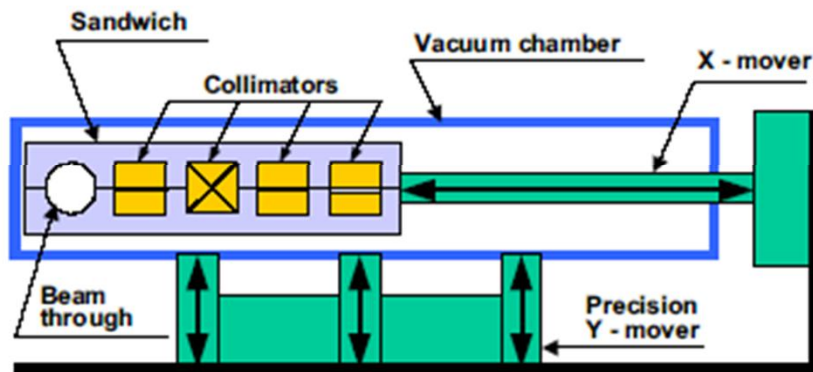
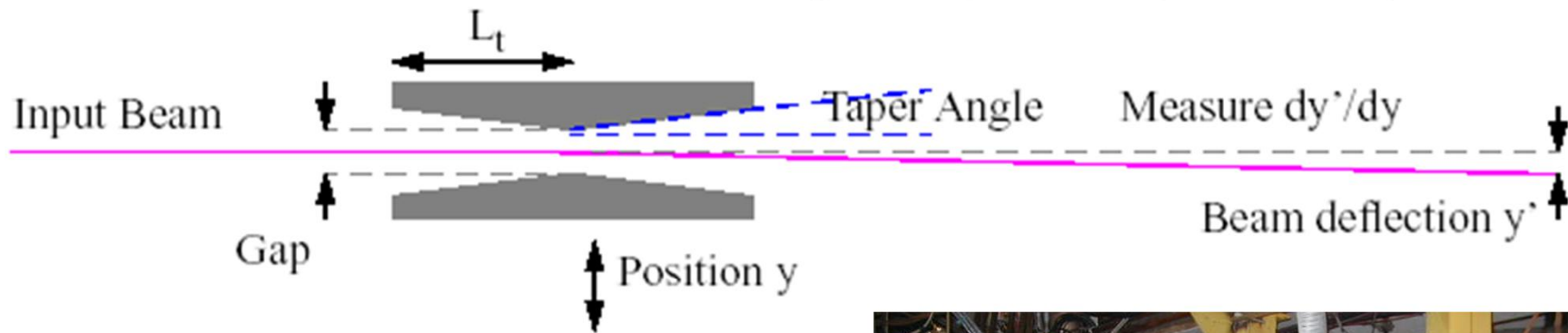

Sample Collimator Wakefield Deflection Measurements

Various Collimator Profiles & Materials

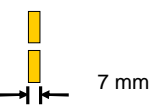
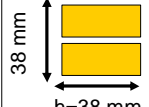
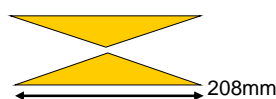
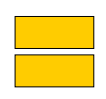
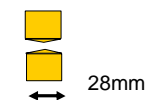
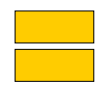
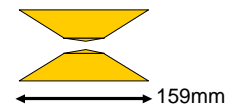
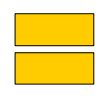
Slot	Side view	Beam view	
1			$\alpha = \pi/2 \text{ rad}$ $r = 1.4 \text{ mm}$
2			$\alpha = 168 \text{ mrad}$ $r = 1.4 \text{ mm}$
3			$\alpha_1 = \pi/2 \text{ rad}$ $\alpha_2 = 168 \text{ mrad}$ $r_1 = 3.8 \text{ mm}$ $r_2 = 1.4 \text{ mm}$
4			$\alpha_1 = 298 \text{ mrad}$ $\alpha_2 = 168 \text{ mrad}$ $r_1 = 3.8 \text{ mm}$ $r_2 = 1.4 \text{ mm}$

Sample Deflection (urad) vs. Position (mm)

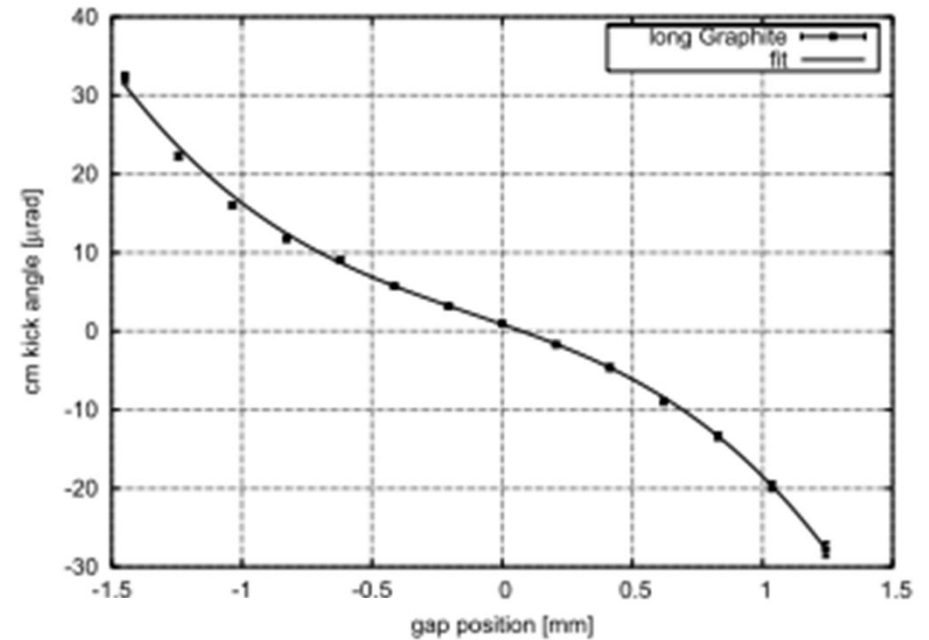

ILC

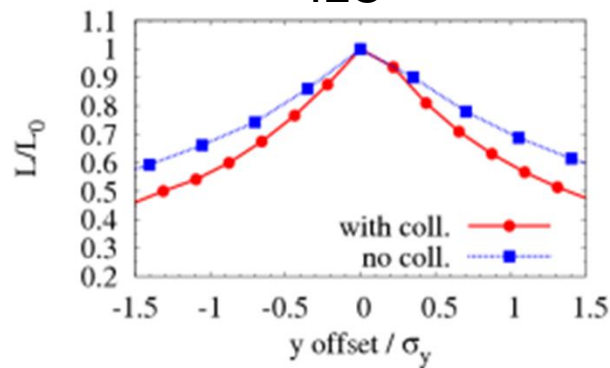

CLIC

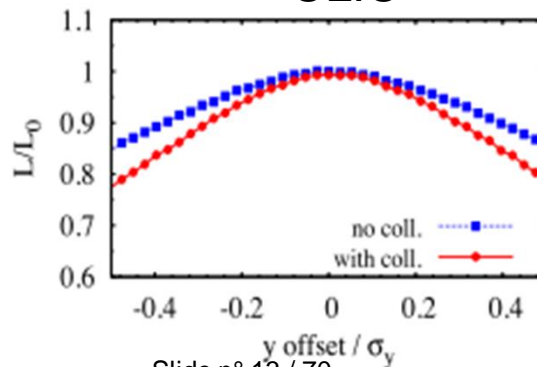

Luminosity vs. Bunch Jitter with & without Collimator Wakes

In ILC Two Caverns Reserved for Tunnel Filling Muon “Spoilers”

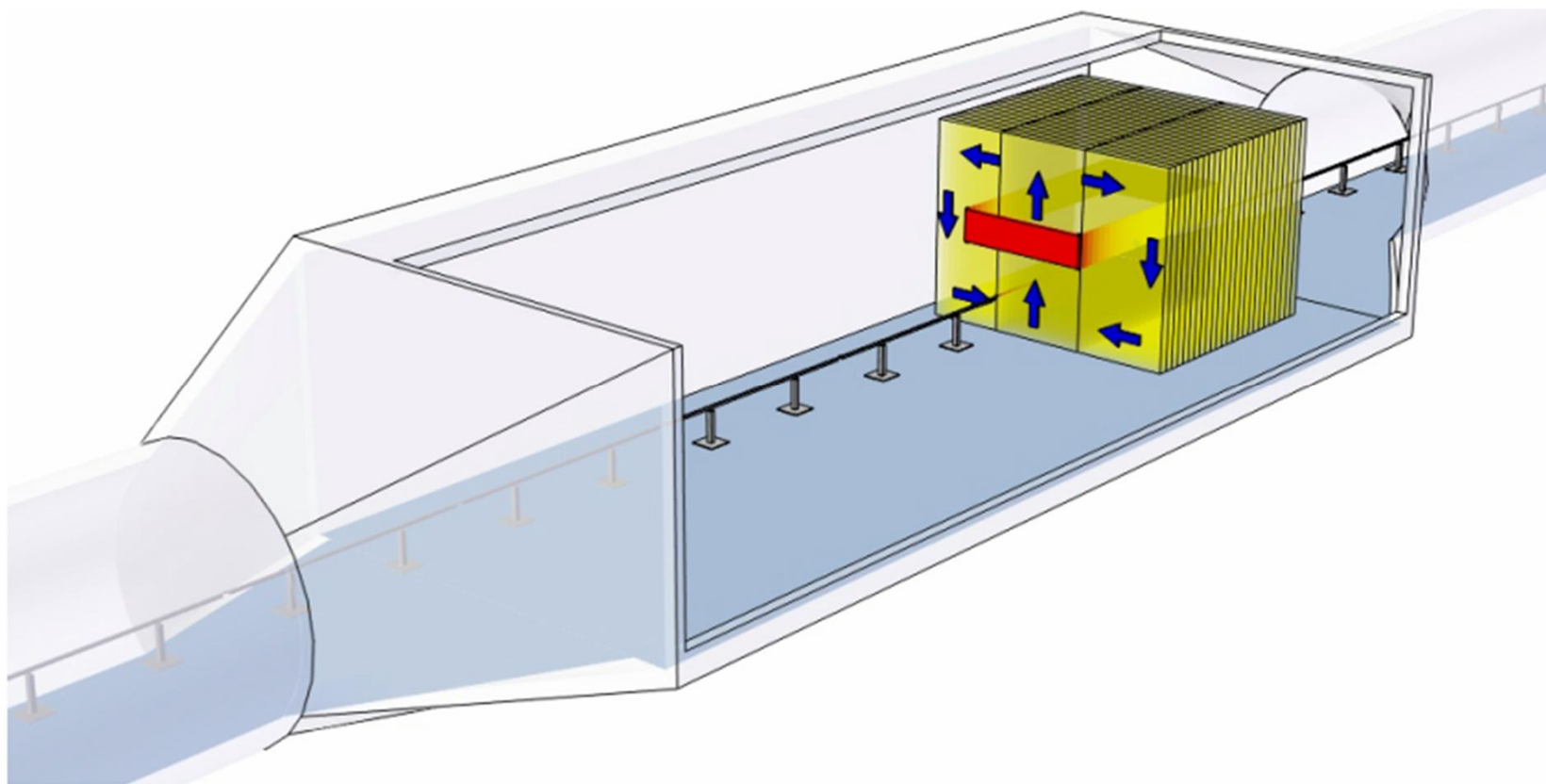

Background Muon Distributions with 0 or 2 Tunnel-Filling Spoilers at 250 Gev/ Beam

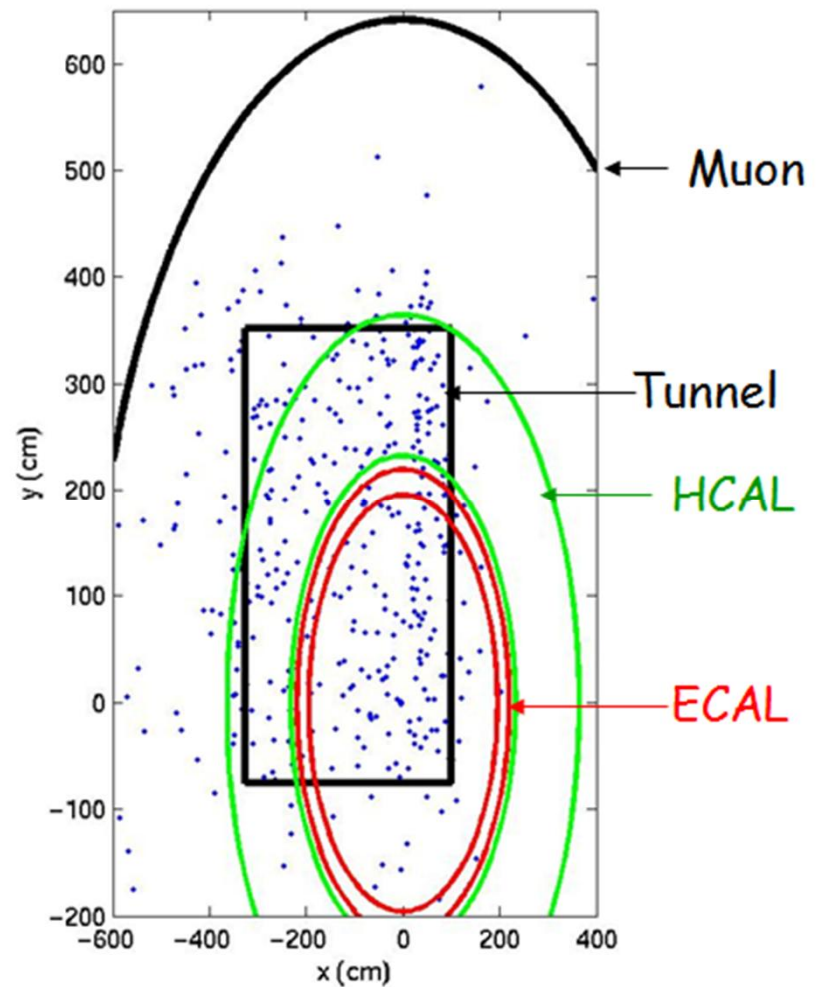
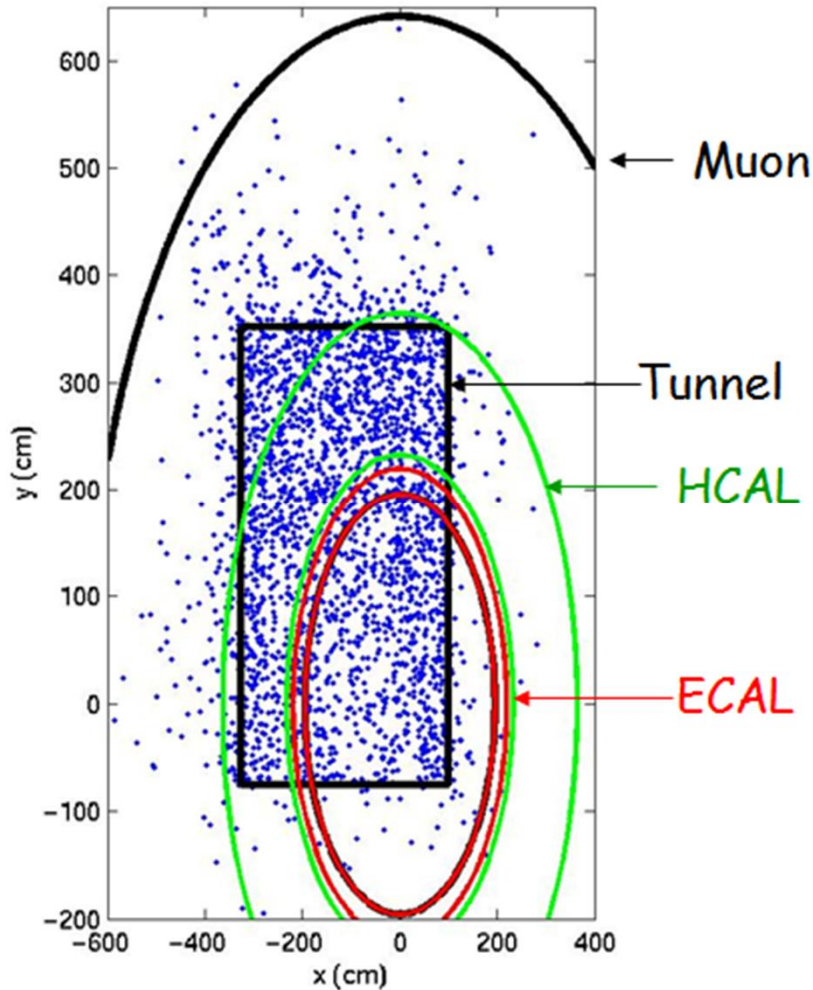

Collimating Disrupted Beam in Extraction Line

1 TeV CM nominal, $\Delta y = 100$ nm

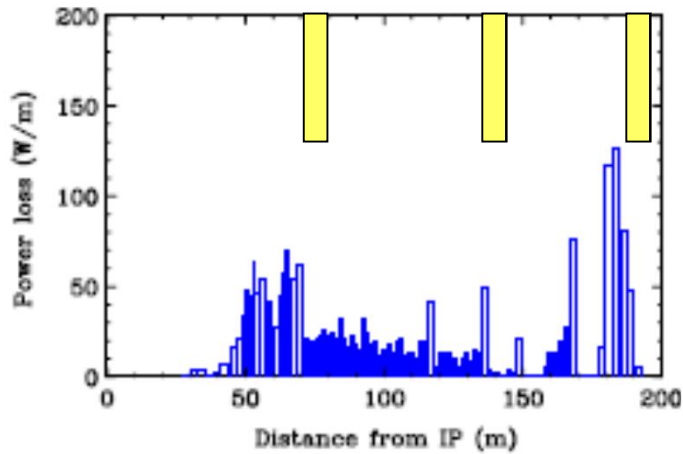

1 TeV CM high-L (c25), $\Delta y = 80$ nm

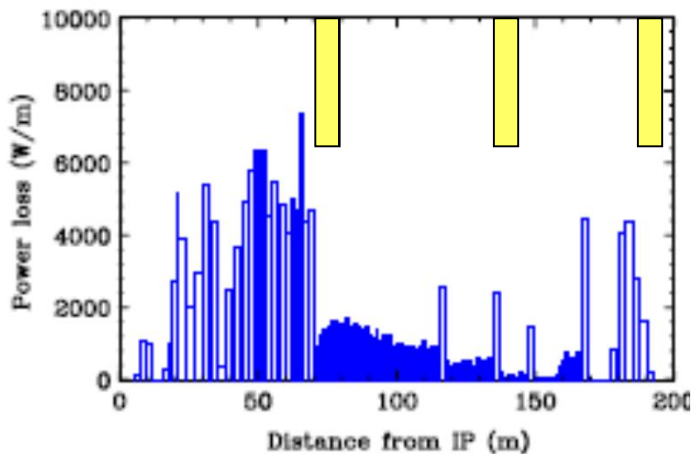

Basic Device Technology assigned based on incident power, beam energy and particle type

- 18MW-600kW: Pressurized water dump
- 600kW-40kW: Metal balls in water bath
- 40kW-25W: Peripheral cooled solids
- 25W – 0W: Un-cooled metal

50cm Diameter x 2m long Aluminum Ball Dump with Local Shielding

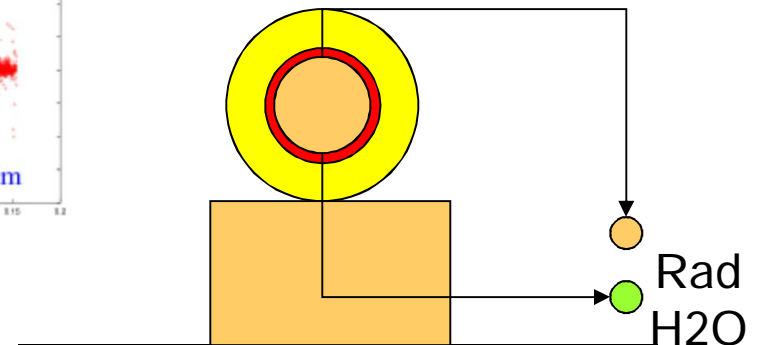
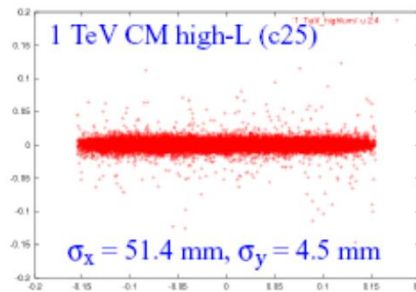

Handy #: 3.8 gallons/kW/°C Δ T

Damageable Collimators Share Pain of Magnet & Collimator Tolerances

SLC experience

- Frequent energy errors &/or feedback system problems
- Few catastrophic quad failures

NLC MPS requires pulse-to-pulse orbit monitoring

⇒ Relax passive requirement for betatron (but not energy) collimation

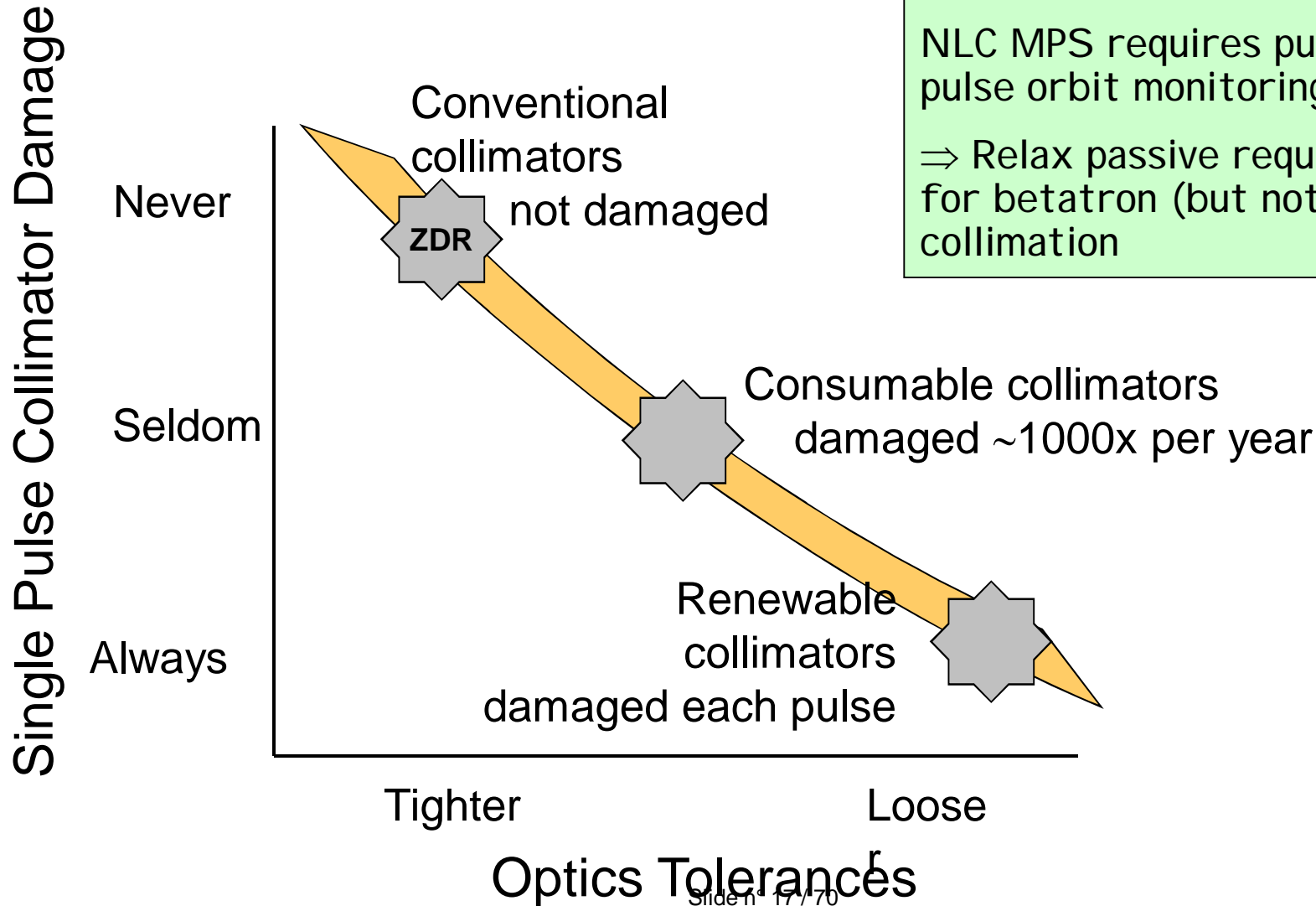

FFTB Coupon Damage Tests

Area of damage very limited

Beam: 30GeV, 3-20x10⁹ e-, 1mm bunch length,
 $\sigma_{xy}^2 \sim 45 - 200\mu\text{m}^2$

Test sample: copper, 1.4mm thick. Single pulse tests.

Damage was observed for beam densities $> 7 \times 10^{14}$ e- / cm².
Picture is for 6×10^{15} e-/cm².

8 μm x 6 μm beam
~10 μm x 10 μm hole

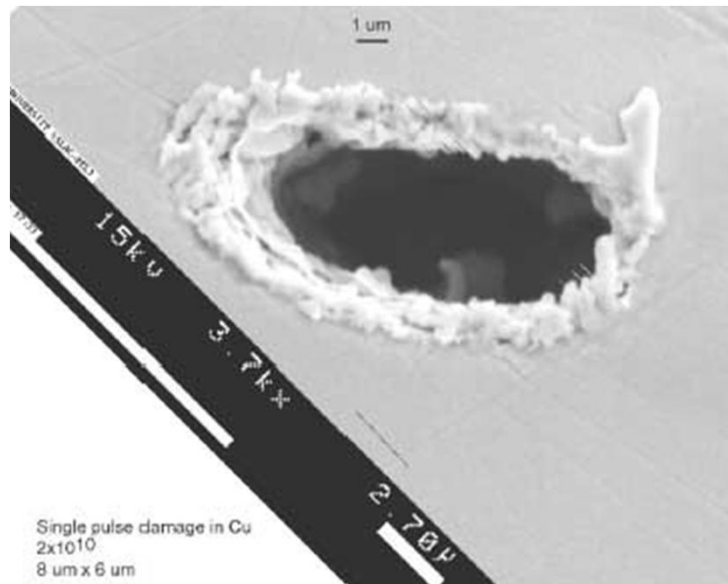

Consumable Options Considered for NLC

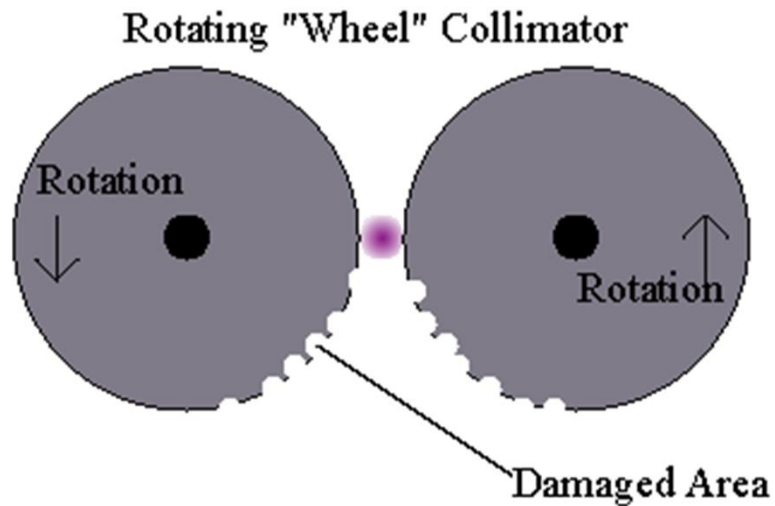

Option
Chosen

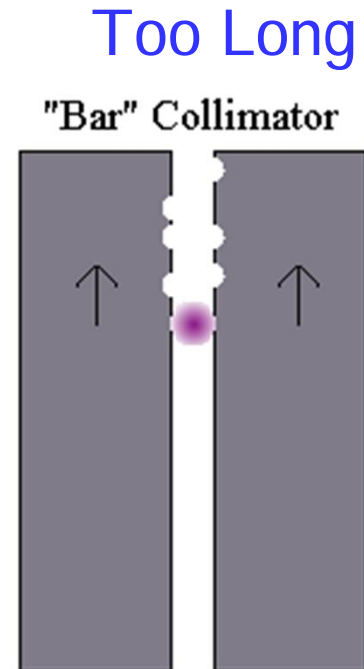
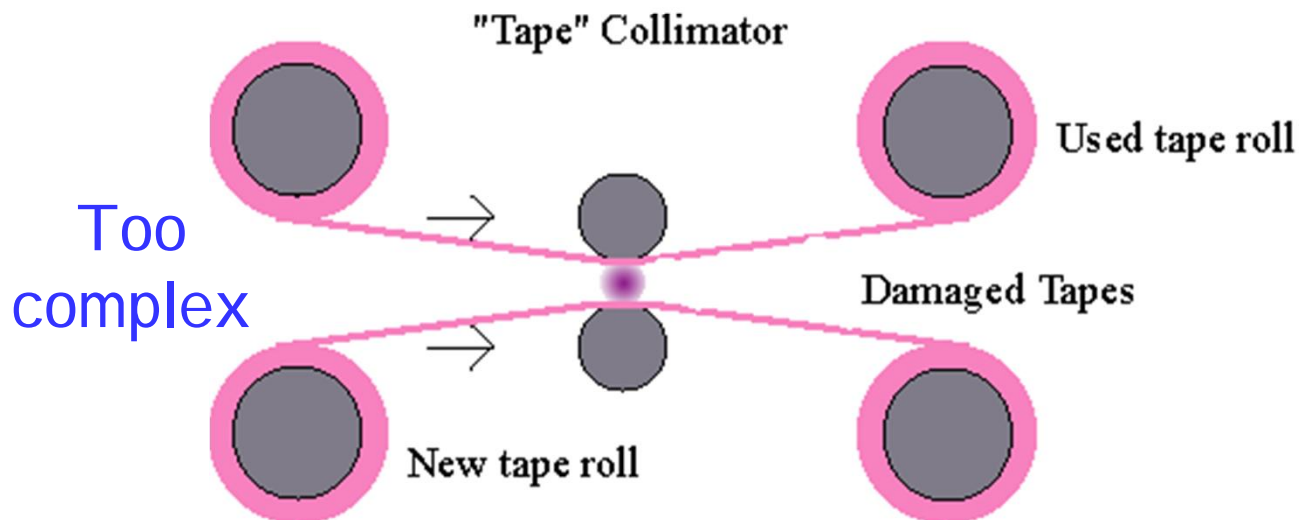

Consumable Spoiler Requirements for e+e- Linear Collider

Max. # Damaging Hits	1000
Length @ Min. Gap	0.6 rl
Radius of curvature	.5 m
Aperture	200-2000 μm
Edge Placement Accuracy	10-20 μm
Edge Stability under rotation	5 μm
Beam Pipe ID	10 mm
% Beam Intercepted per side	.05%
Beam Halo Heating	~0.2 W
Image Current Heating	~0.5 W
Radiation Environment	$10^5 - 10^6$ rad/hour
Vacuum (tbd)	$<10^{-7}$ torr

~30cm
diameter

Very Low
Operational
Heat Load:
Radiative
Cooling Only

Consumable Rotating Wheel Collimator Design Features

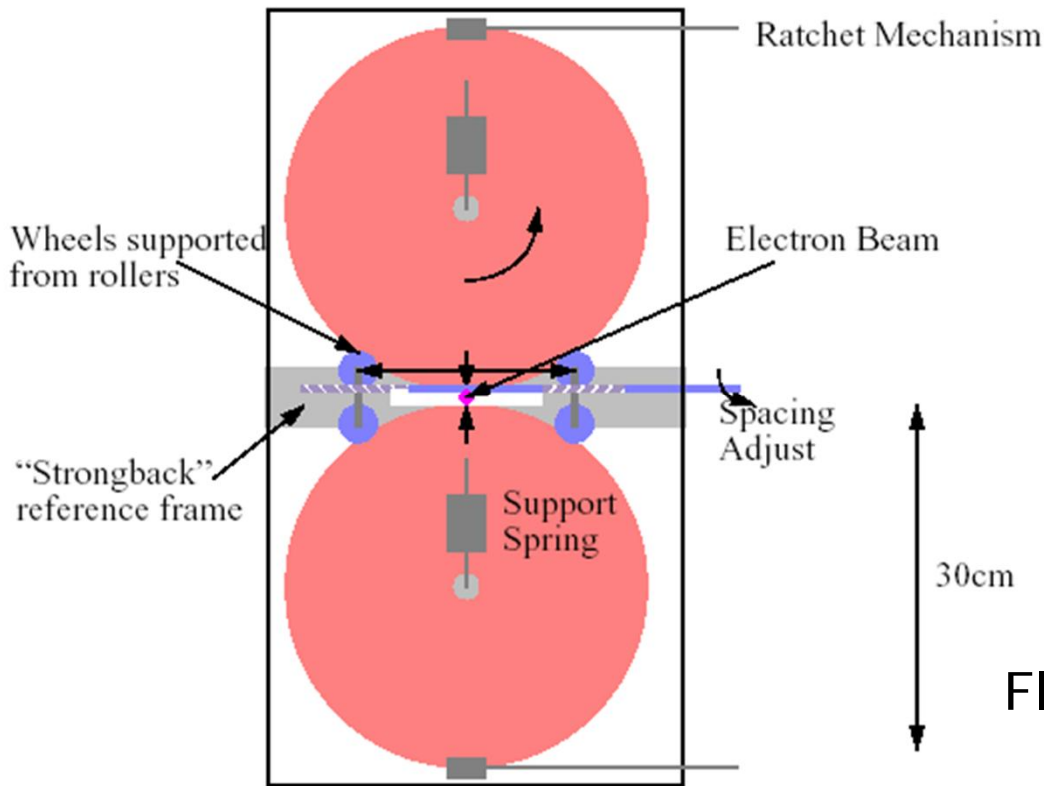

1 d.o.f. internal mechanism
referenced to rigid backplane
provides aperture

Control through transversely
adjustable stops

Flexure pivots eliminate backlash

Vacuum bearings

Housing aligned to beam via
external movers & BPMs

Engineer to minimize thermal
effects

Consumable Spoiler Prototype Constructed & Mechanically Tested

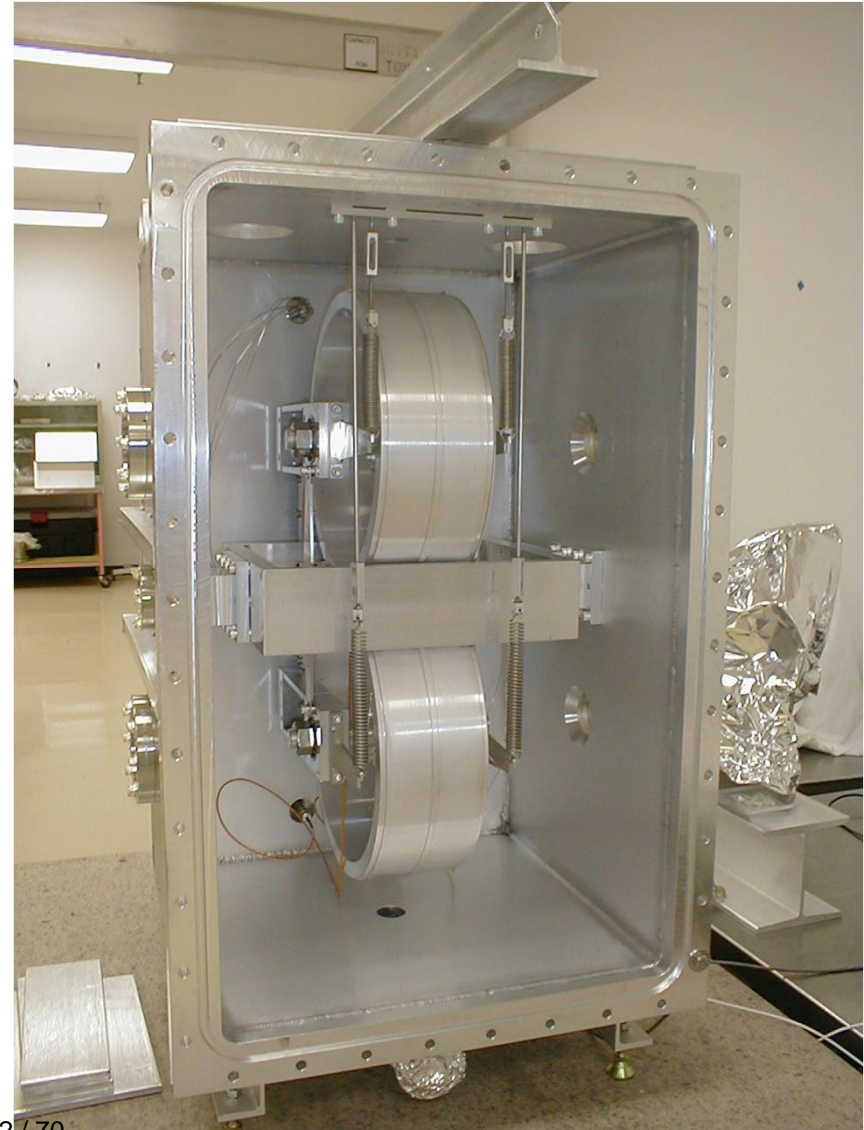
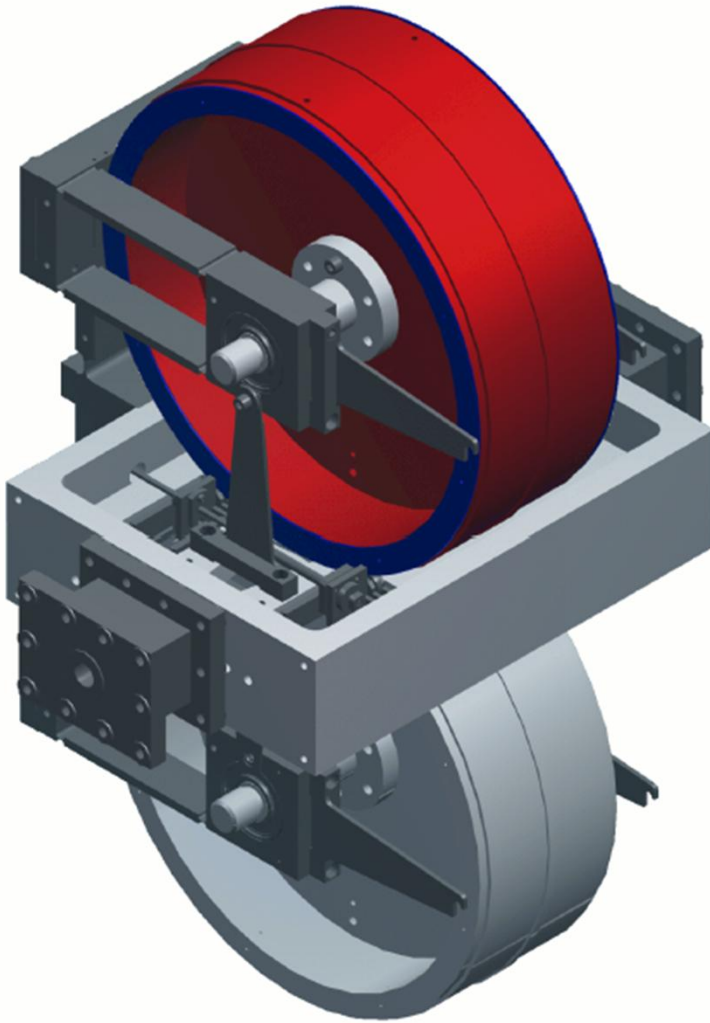

One screw adjust to change collimator gap One ratchet & tooth to change surface seen by beam

Wheel Ratchet
& Support

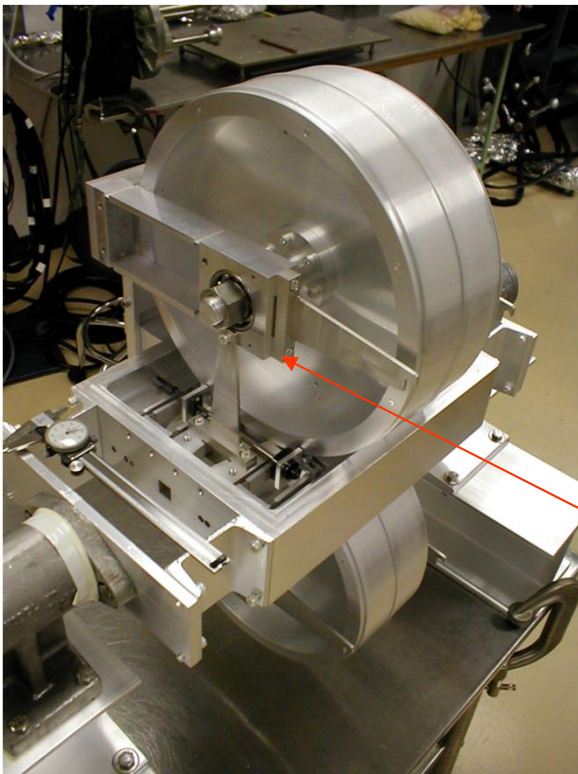
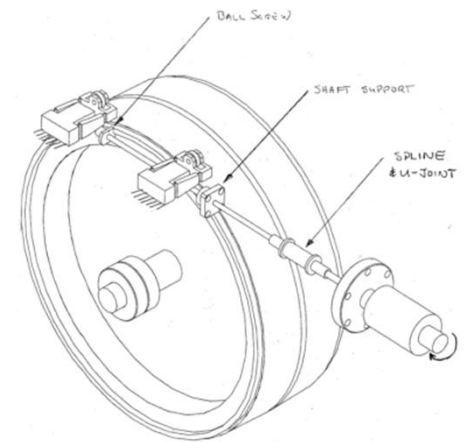
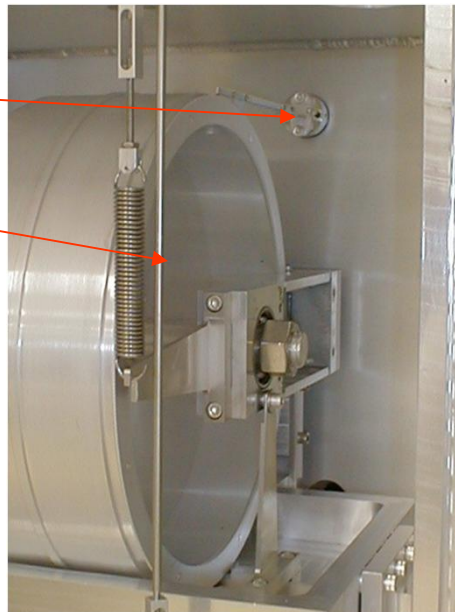

Aperture Adjust

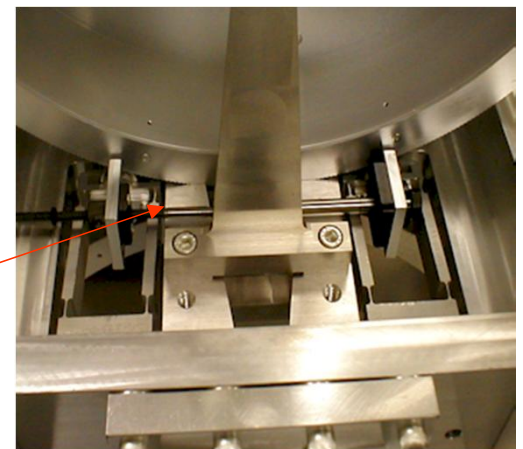

Rotatable Spoiler Performance Adequate & Understood: **Prototype Considered a Success** at time when ILC becomes Baseline e+e- Machine

Gap Stability with Wheel
Rotation $\sim \pm 15 \mu\text{m}$

Runout in support bearings;
Use higher precision bearings

Gap Control accuracy $\sim \pm 15 \mu\text{m}$
OK

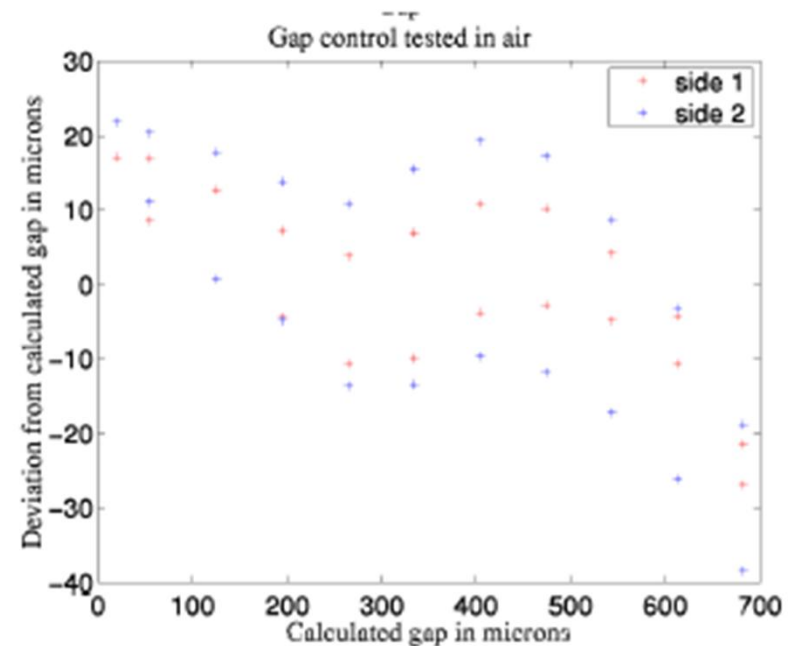
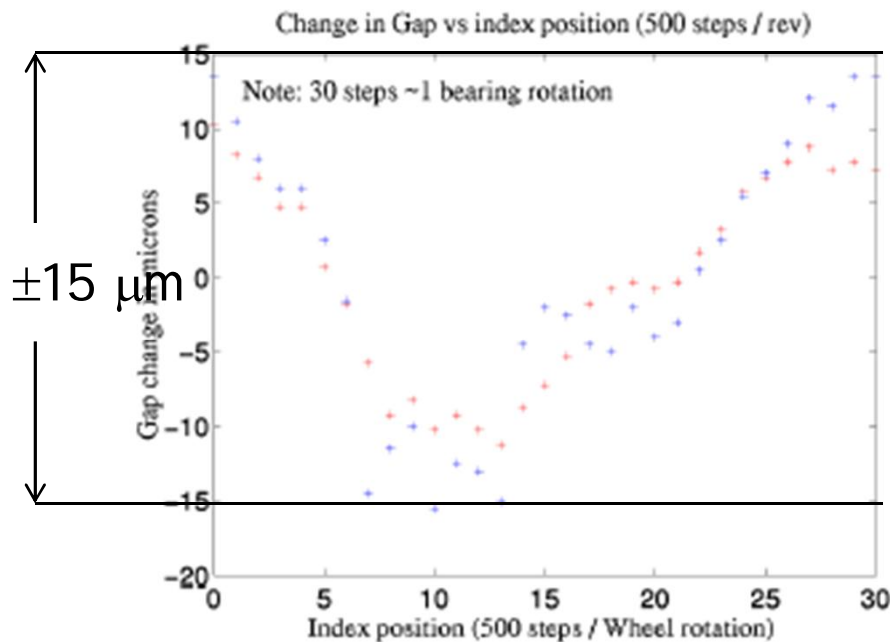

“Renewable” Spoilers Also Considered and Prototypes Attempted: **NOT successful**

Solidifying metal system - one side shown

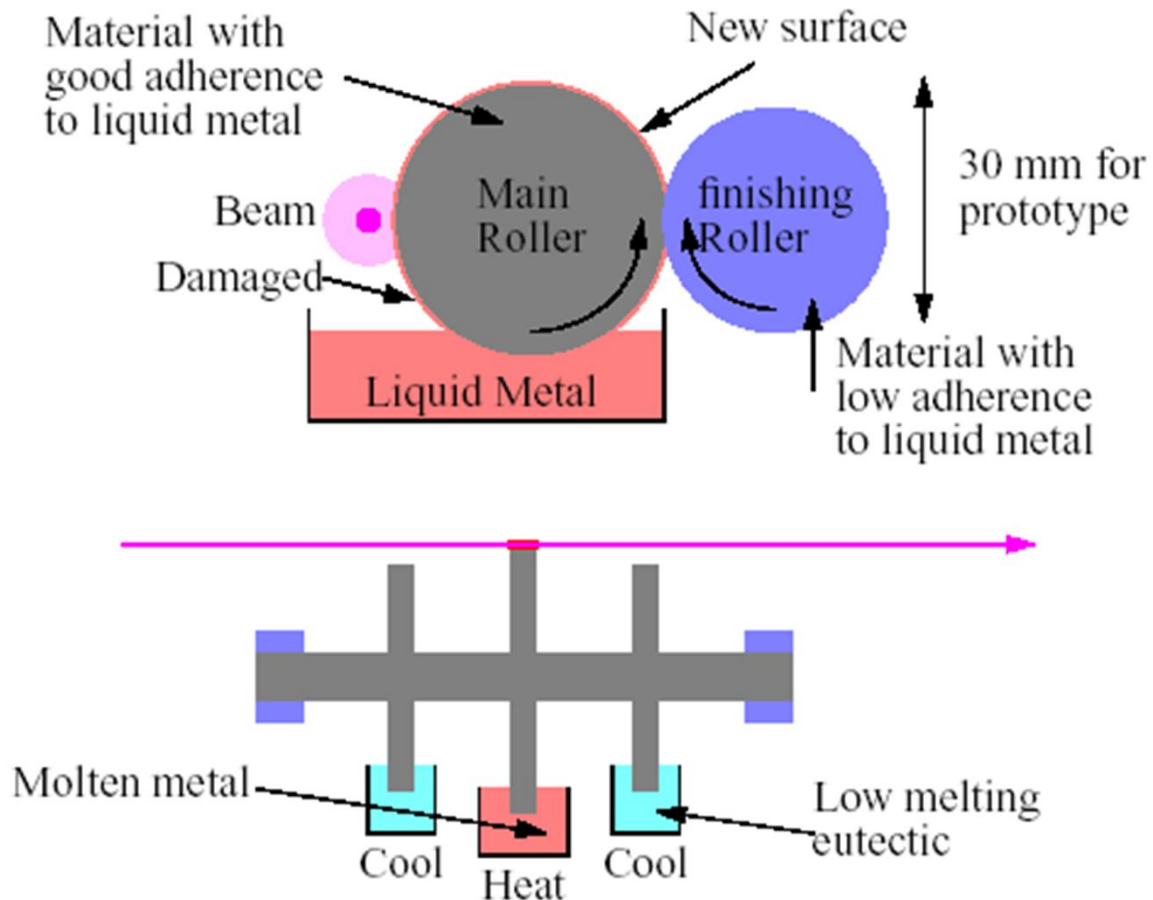

Many materials exposed to **Sn** & Indium

Best:

Sn-coated Niobium as Main Roller

&

Molybdenum as smoothing roller

Gallium as low melting eutectic

Very Small Gap relaxes optics tolerances

•No need to ask if surface is damaged or not

Materials R&D



Glove Box under
N₂

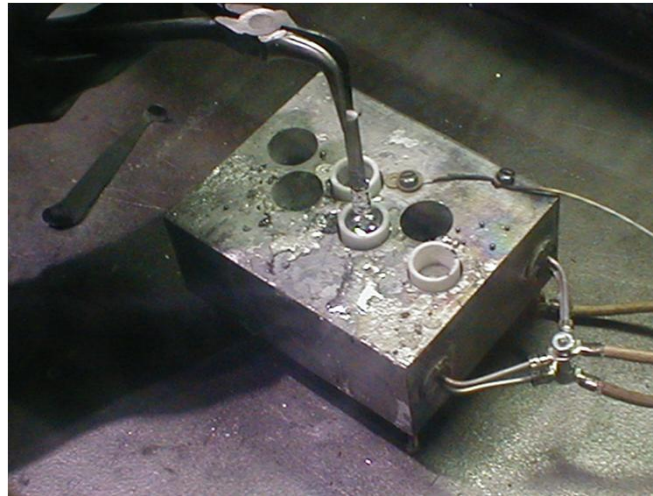

Zirconium / Tin
(Crystal formation)

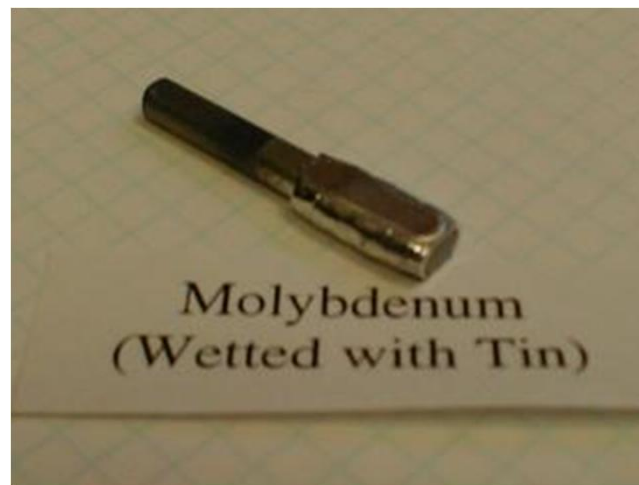

Molybdenum
(Wetted with Tin)

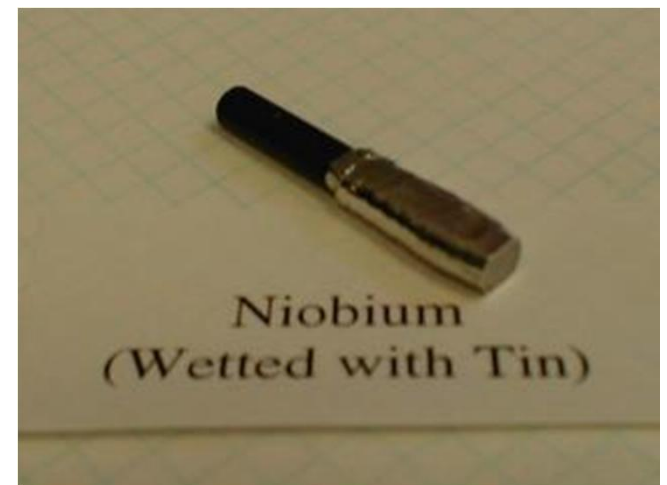

Niobium
(Wetted with Tin)

Renewable Spoiler Prototype Assembly

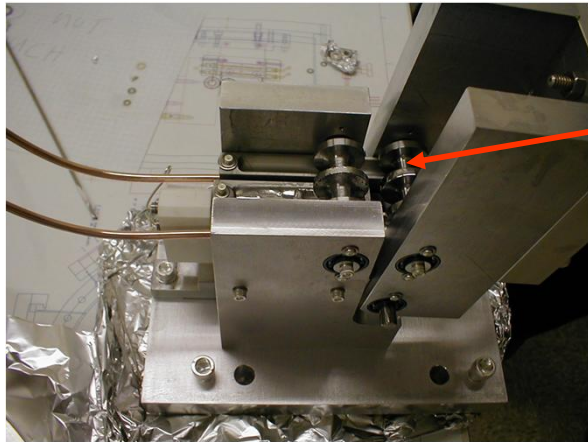

Niobium and Molybdenum Rotors

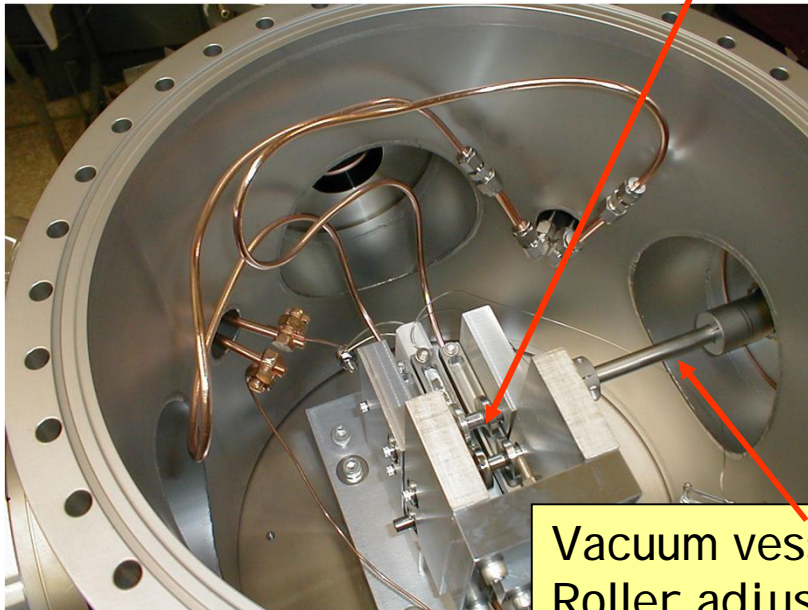
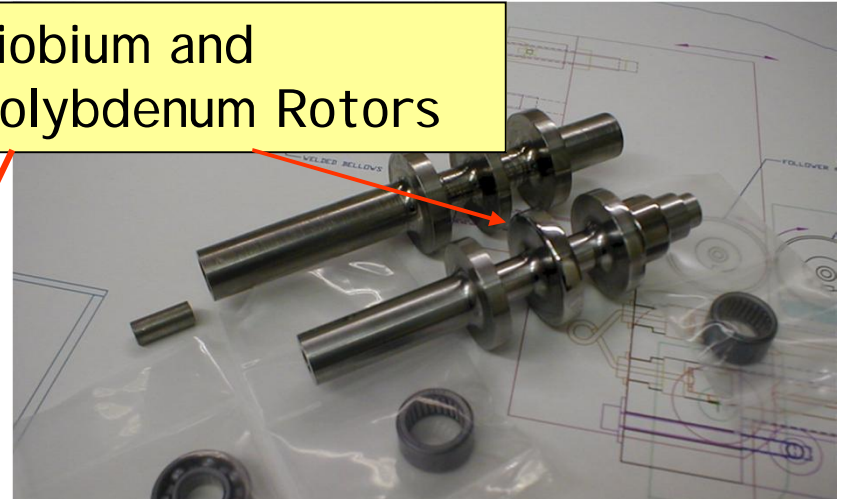

Vacuum vessel & Roller adjustment

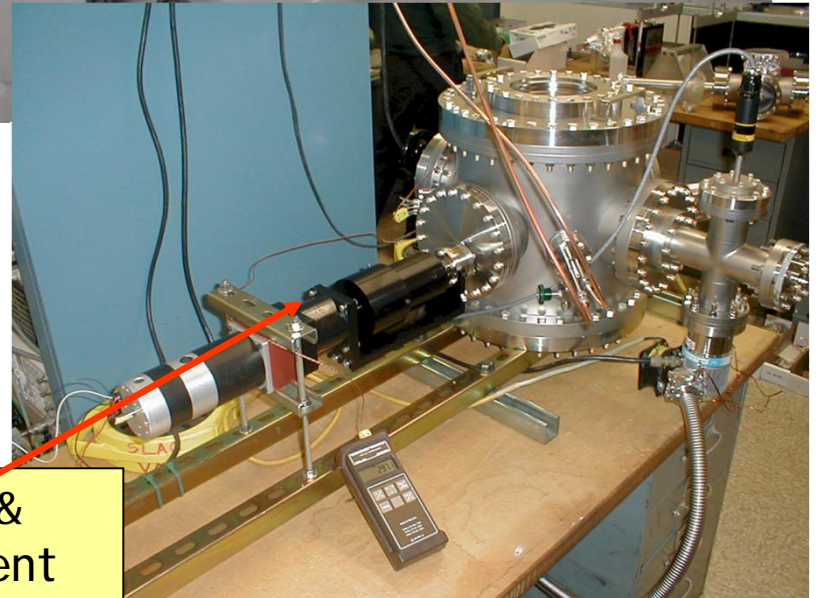

Renewable Spoiler Operation

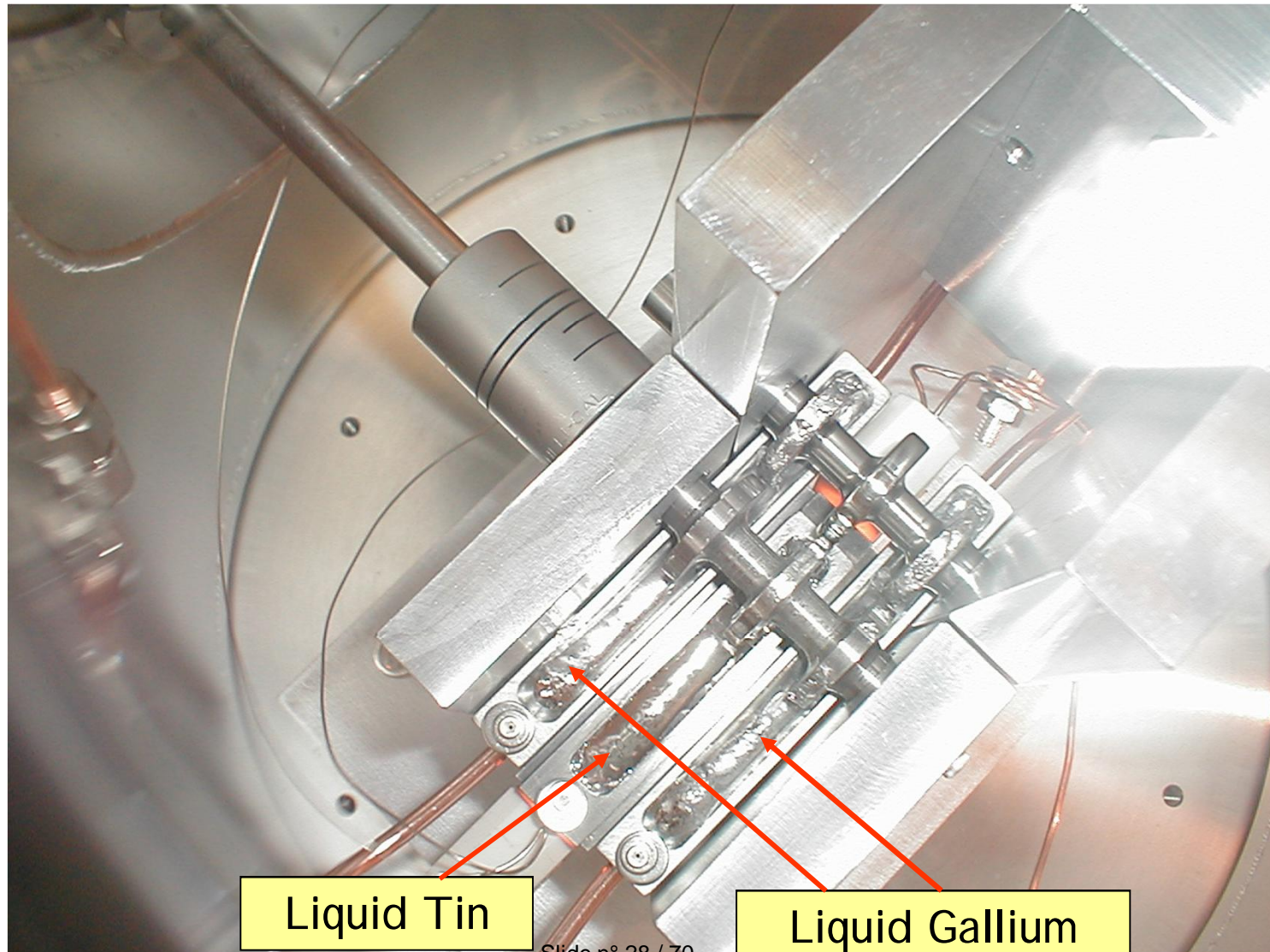

Liquid Tin

Liquid Gallium

Results: Uncontrollable buildup of Sn and Bearing Failure

Given success of the “Rotatable” spoiler decision
made to suspend this line of R&D

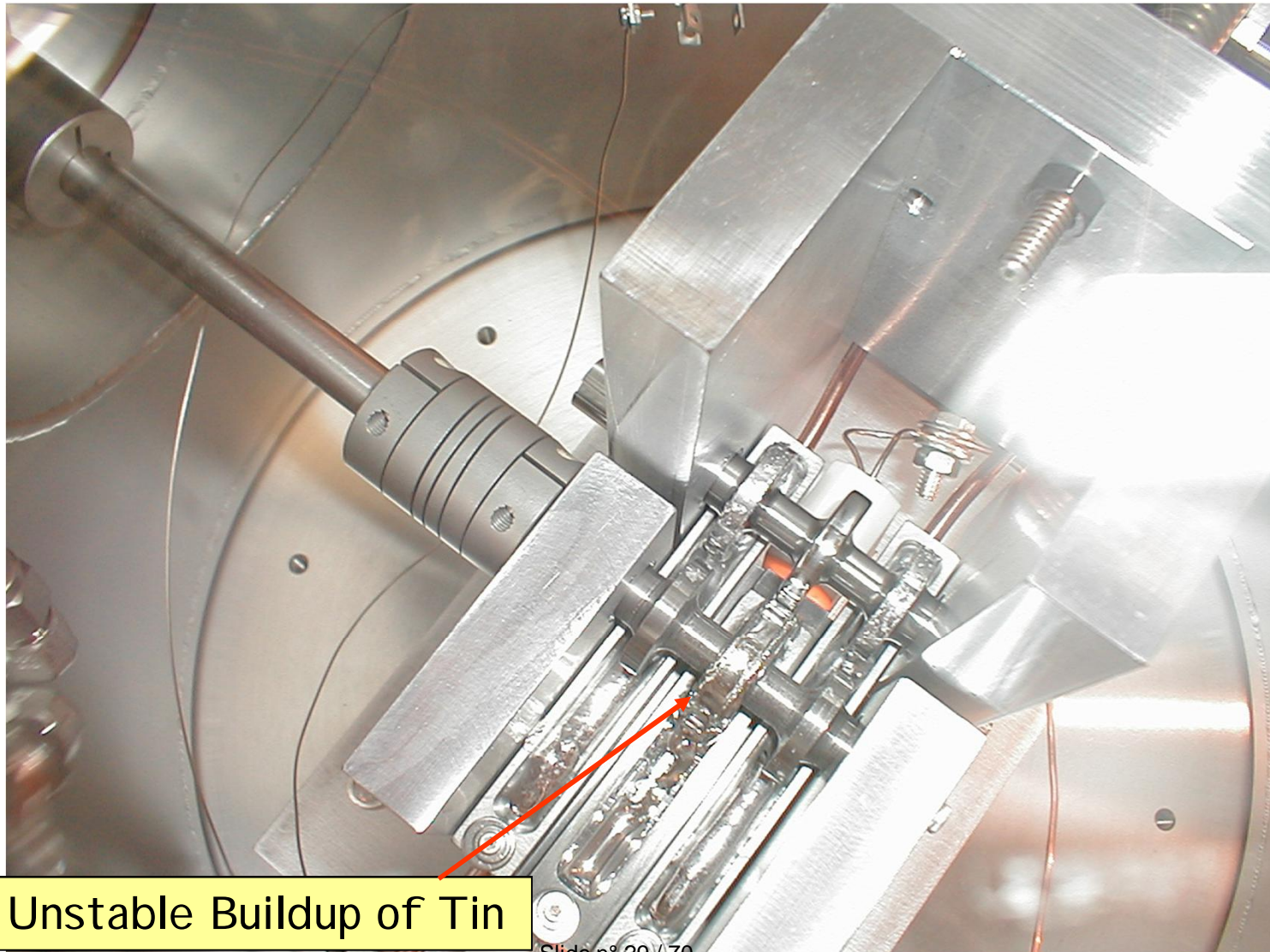

Unstable Buildup of Tin

LHC Collimation R&D

Near term R&D for:

- BPM equipped collimators
- Secondary collimators based on the Mo-Gr material discussed by Alessandro Bertarelli
- Collimators to be inserted in the cold areas of LHC after new shorter 11 Tesla Nb₃Sn dipoles are inserted to make space

Next to Near Term R&D:

- LARP “Rotatable” Collimator for LHC
- Hollow Electron Lens Beam Scraper
- Crystals as primary collimators

BPM Equipped Collimators are part of the LS1 Upgrade

After years of discussion, analysis, design & production, during LS1 CERN installed BPM equipped collimators so that collimator positions could be set relative to the beam orbit permitting more efficient setup and tighter tolerances

16 Tungsten Tertiary Collimators

2 CFC Secondary Collimators

Eventually, all newly installed collimators will be equipped with BPMs

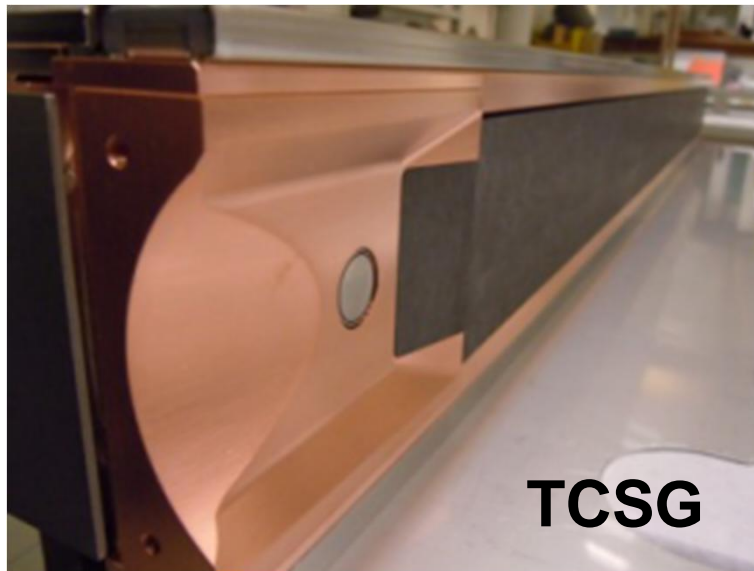

Example of Collimator Jaw Alignment Efficiency

Alignment w.r.to beam measured in seconds
All collimators can be done in parallel

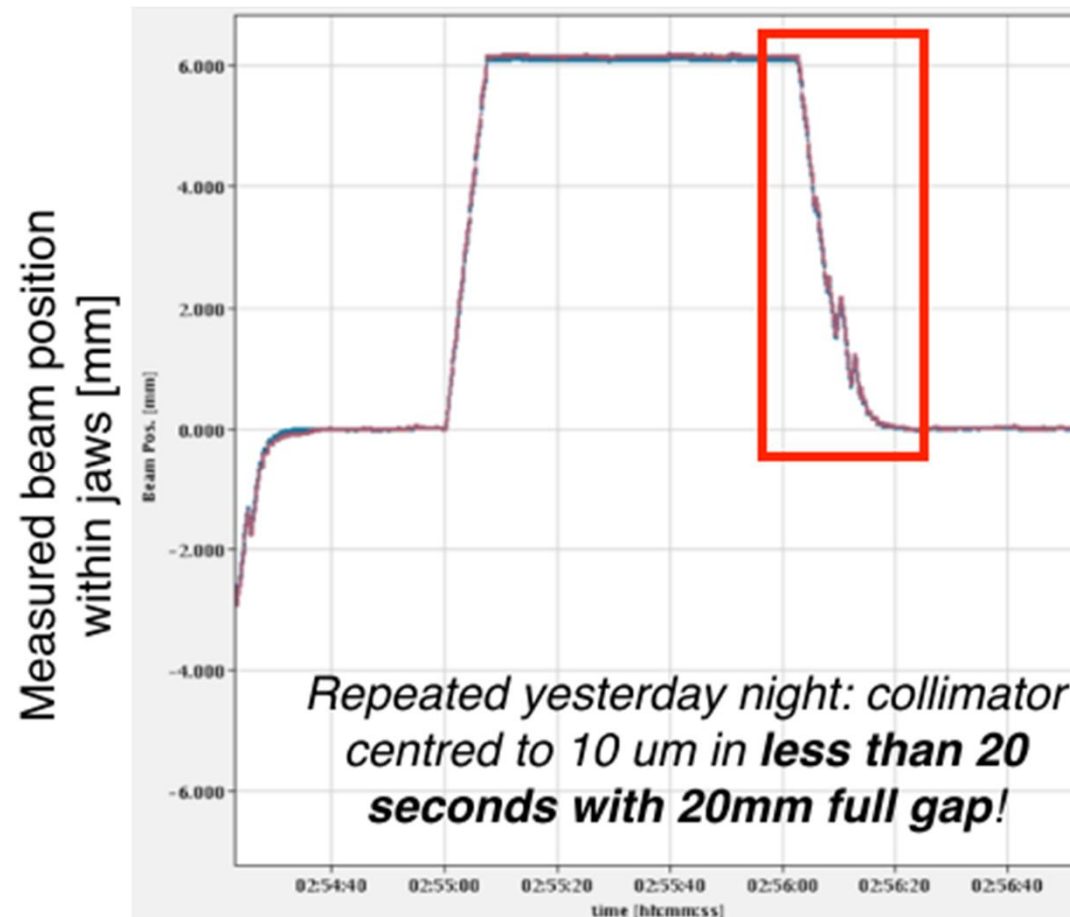

Collimators in the Dispersion Suppressor Regions of LHC

Tracking studies with full aperture model reveal what limits LHC luminosity; confirmed via operational studies since 2010

- “single diffractive” interactions in primary collimators or via beam-beam collisions at IPs produce slightly off-energy protons that **miss all secondary collimators** and are lost in cold magnets of the “dispersion suppressor” (DS) sectors surrounding IR3, IR7 & IRs with experiments
- To make space for these collimators, either:
 - Modify lattice by **shifting SC magnets** in DS to make room for two “Cryo” collimators (per side per insertion)
 -  – Replace 2 dipoles with new shorter **11 Tesla** dipoles based on Nb₃Sn conductor (fallout from LARP program)
 - Nb: Nb₃Sn also more radiation tolerant
 - These “cryo collimators”, modeled as 80cm Tungsten 2-sided jaws at 15 sigma, **improve intensity limit by x15-50**

Plan is for an implementation of 2 units (4 dipoles) in IR2 during LS2

Timeline set by 11T development

Other IR's can follow in LS3

Calculated Improvement with 11T Dipoles and DS Collimators

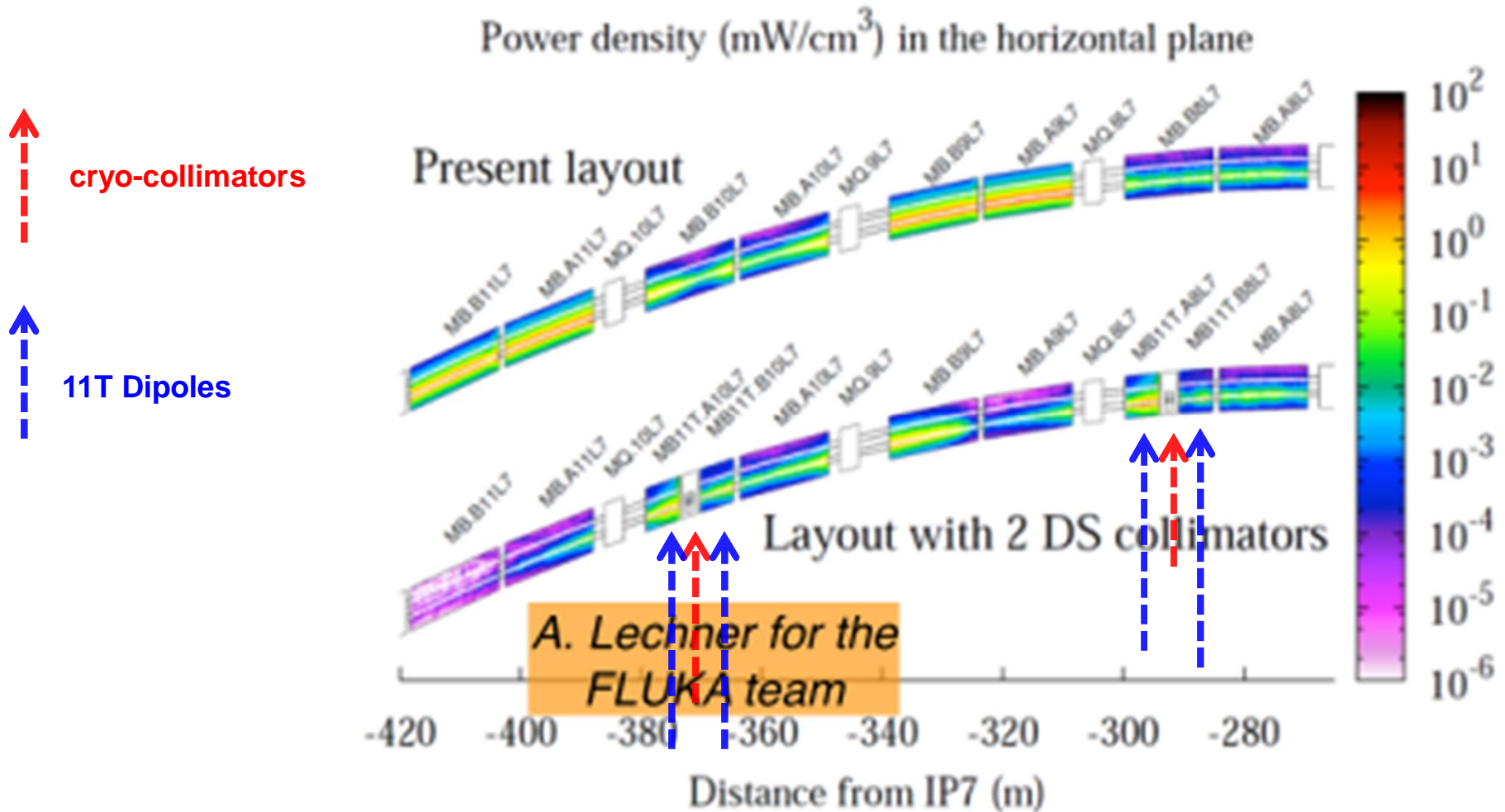

“TCLD” collimator design

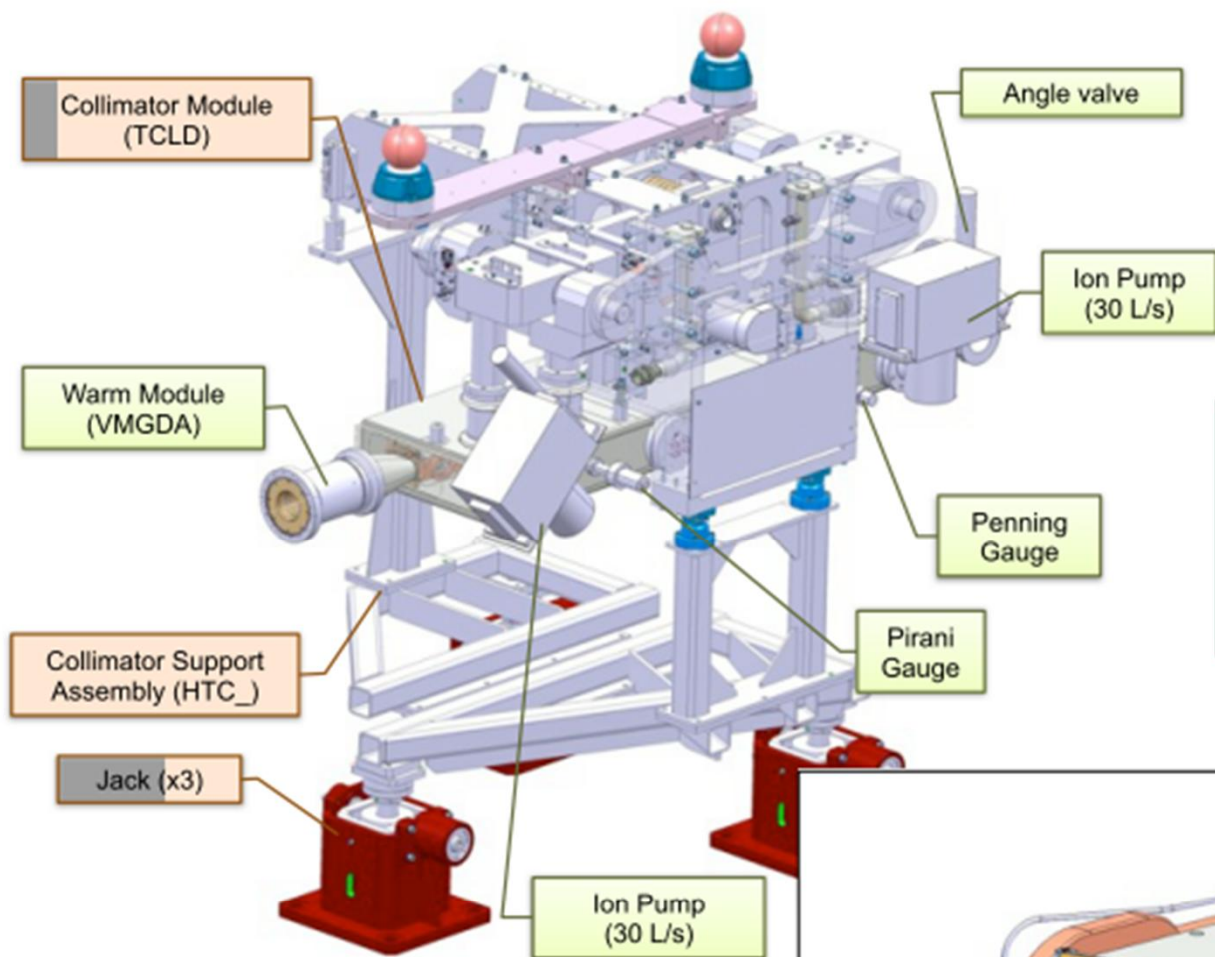

Agreed on a baseline of 80 cm!

Ongoing detailed integration work. Installation between 11T dipoles seems feasible with present design!

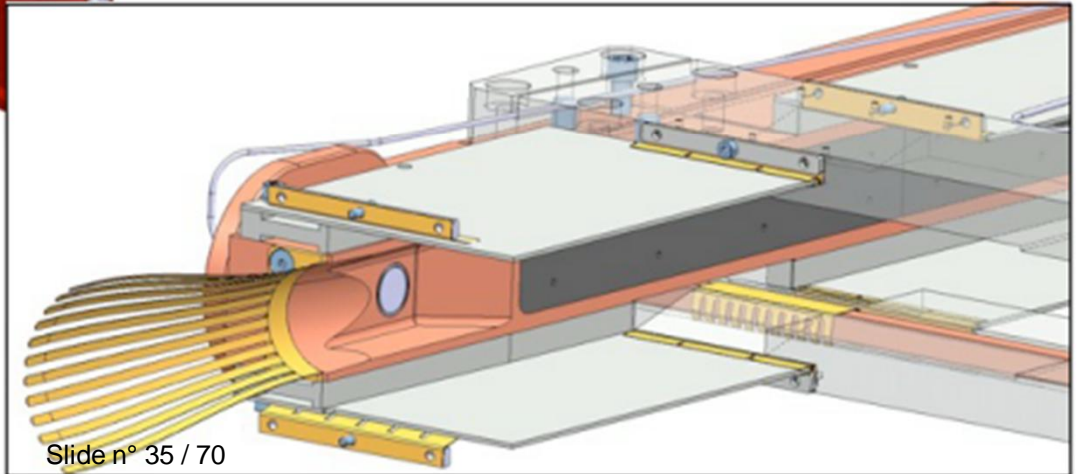

L. Gentini et al.

Slide n° 35 / 70

TCLD integration

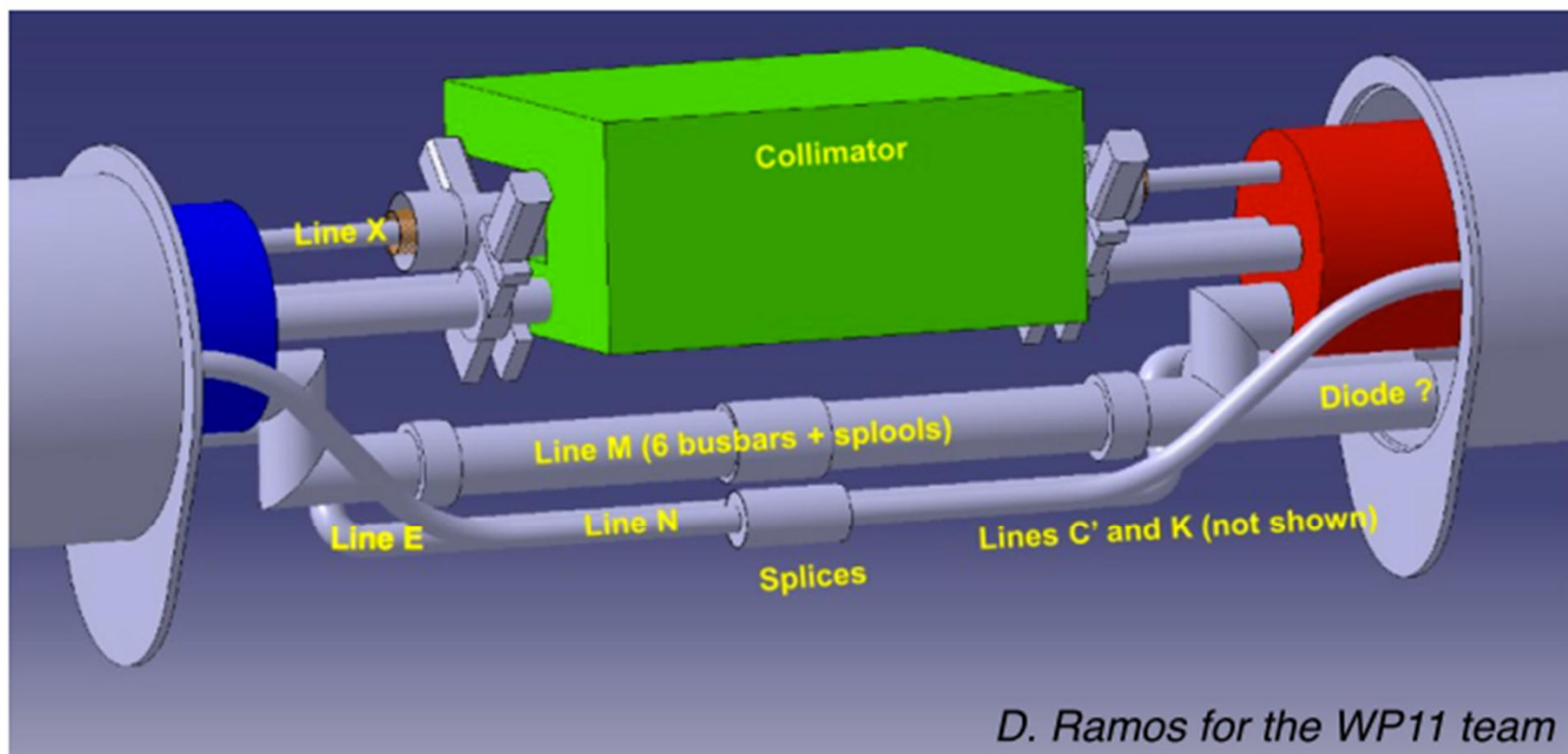

Related ongoing activities:

- iterations with vacuum team for integration optimization;
- finalize bus-bar design;
- finalizing TCLD design (RF fingers vs ferrite) for prototyping phase;
- tests of cryogenics by-pass scheduled at the SM18.

HRMT14: High Intensity Tests: Material Studies shown by Alessandro Bertarelli on Saturday

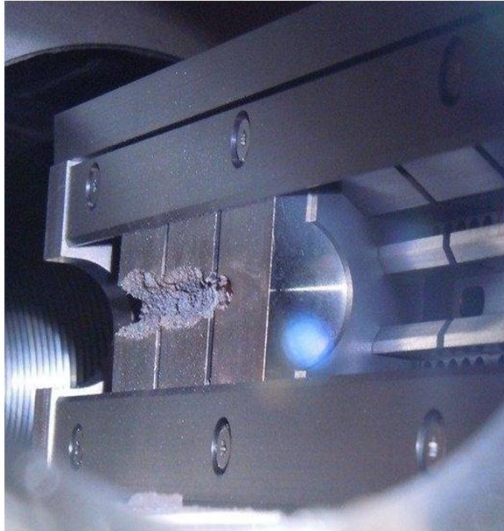

Inermet 180, 72 bunches

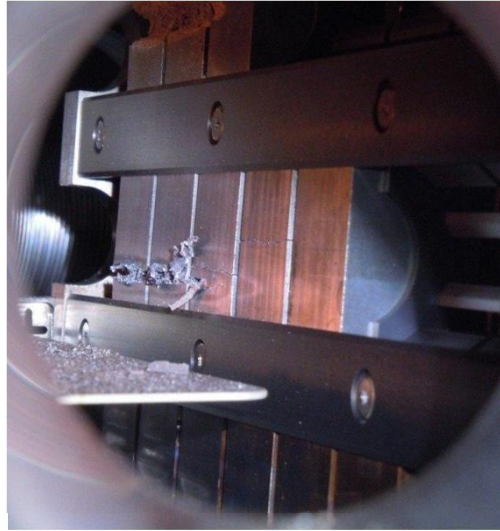

Molybdenum, 72 & 144 bunches

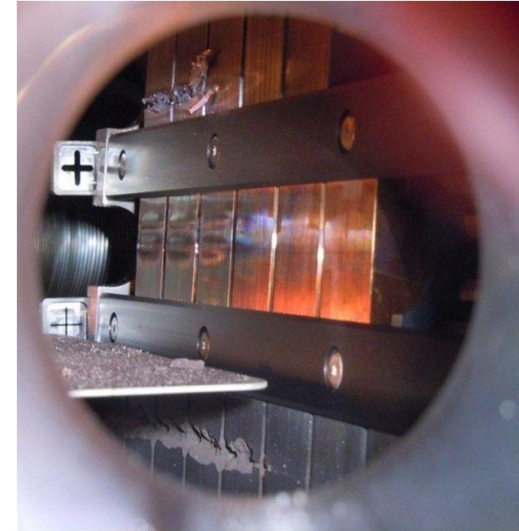

Glidcop, 72 bunches (2 x)

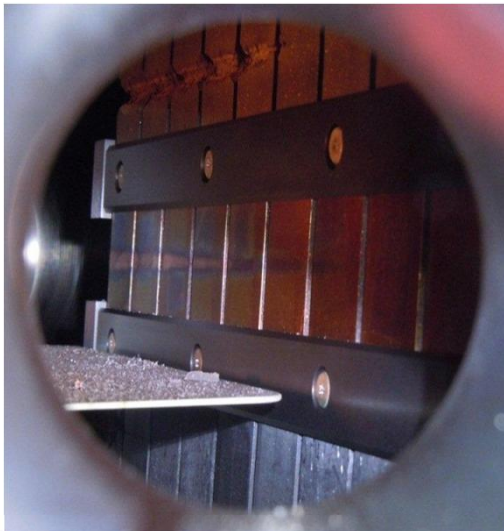

*Copper-Diamond
144 bunches*

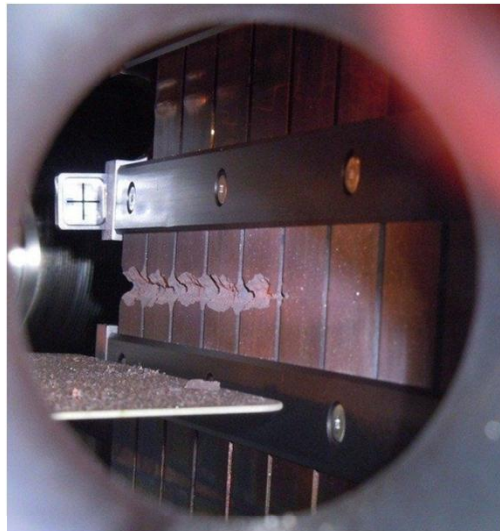

*Molybdenum-Copper-
Diamond 144 bunches*

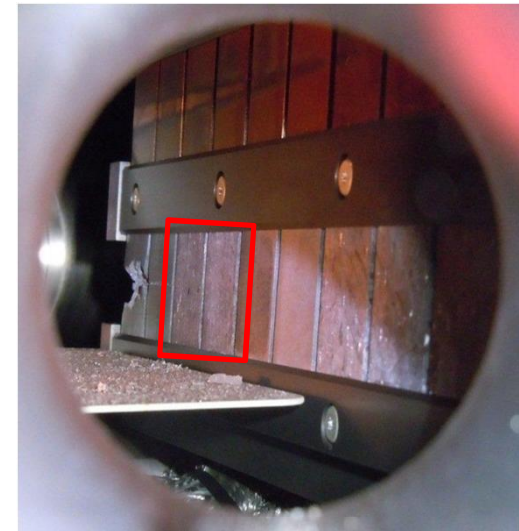

*Molybdenum-Graphite (3 grades)
144 bunches*

Next Step: Prototype Secondary Collimators That Use Advanced Materials

Recall: Goal is to increase efficiency by using higher Z materials, improved impedance, maximize heat transfer and minimize thermal distortion while maintaining “robustness” against accidental beam impact

Main interest now: Mo-GR composited with or without Mo coating.

Plan:

- Build a machine-ready prototype for installation over Christmas 2015!
- Based on post-LS1 experience and results of prototyping, prepare a possible series production for installation during LS2
 - replace IR7 secondary collimators and tertiary collimators

Challenges ahead:

- Finalize new collimator design
- Production techniques for new materials, including coating
- Beam validation of full scale prototype at CERN HiRadMat
- Crucial tests of material properties under high irradiation
 - Results expected from US-LARP (BNL) and Kurchatov.

HRM-23 Tests: 3 Collimator surfaces each with full cooling: Mo-Graphite, Cu-Diamond, CFC Phase I w/BPMs

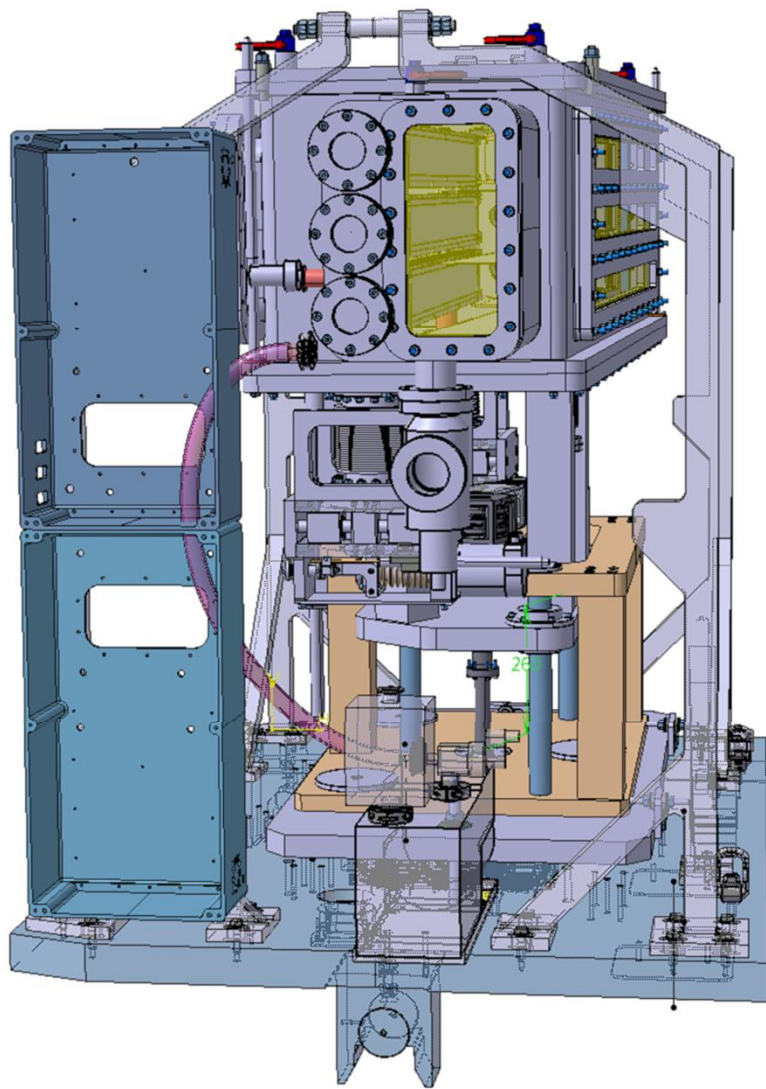

10 tiles/jaw

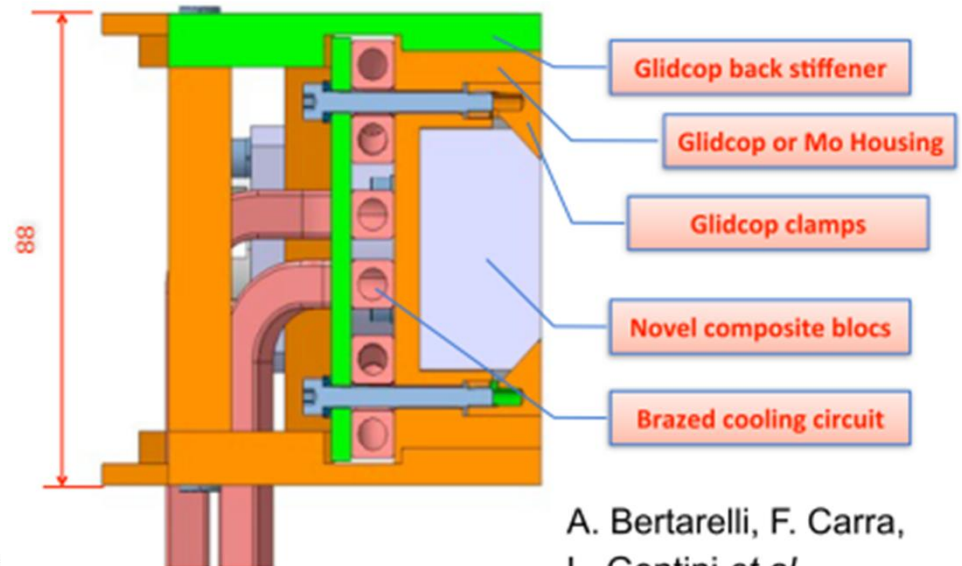
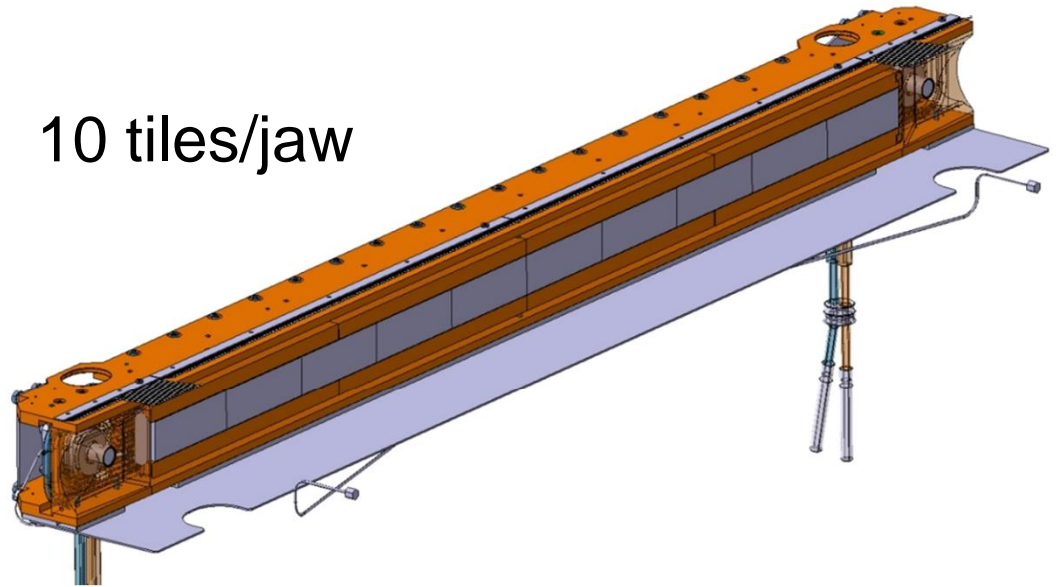

Slide n°

A. Bertarelli, F. Carra,
L. Gentini *et al.*

The LARP Rotatable Collimator Prototype Candidate for a Phase II Secondary Collimator

Two jaw collimator made of Glidcop

- Rotate jaw after 1MJoule beam abort failure accident occurs

Each jaw is a cylinder with an embedded brazed cooling coil

- No vacuum-water braze; 12kW/jaw cooling; minimal thermal distortion
- Maximum radius cylinder possible given beam pipe separation
- BPMs integrated on ends of tank

Advantages:

- Not exotic material
- High Z for better collimation efficiency & more debris absorption
- Low resistance for better impedance
- Elemental for high radiation resistance

Disadvantages:

- Glidcop **WILL** be damaged in asynchronous beam abort

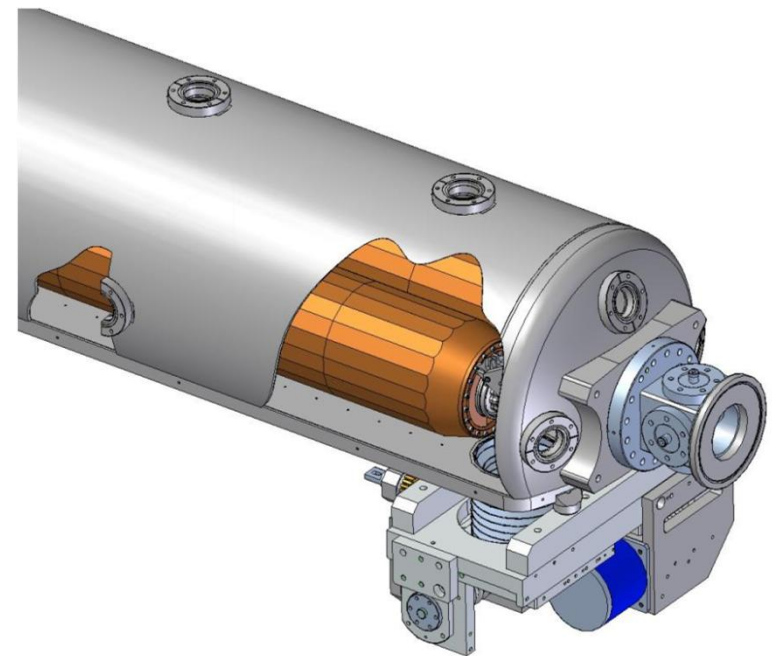

Initial LHC Collimation Plan

Decision made in 2003 to install a collimation system based on **CARBON** jaws which would survive impact of 8 full LHC bunches (1 Mjoule) if **abort kicker misfires** with respect to abort gap (expected rate < 1x/year)

- Called **Phase I** because, while “robust”
 - Impedance might limit maximum luminosity to ~25% nominal
 - Halo “Cleaning efficiency” not adequate for nominal or ultimate luminosity
 - Radiation hardness not equal to that of metals
- Plug ready slots left behind each 1m secondary for a **PHASE II** device
 - SLAC approached in 2004 to adapt the “rotatable” NLC collimator design to LHC & to produce a plug-compatible prototype that would fit between existing beam pipes
 - Metal (eventually choose Glidcop (Cu+0.15% Al))
 - When collimation surface damaged, rotate to expose fresh surface to beam
 - Challenges:
 - » Water cooled for 1 hour beam lifetime loss rates
 - » 90kW beam loss; 12kW per jaw absorbed in Glidcop
 - » **Maintain 25um jaw flatness during operation**
 - » **Injection transients of 450kW for 10 sec -> 60kW per jaw absorbed**
 - » Limit local and global damage during abort accident; vacuum; impedance.....

Jaw Designed to Minimize Thermal Distortion

1 hour beam → 12kW with 10 second transients x5 → 60kW

- Continuous 15m copper tube wrapped on copper mandrel
 - Tube enters from far end of mandrel then begins spiral to provide ~1m free length that can twist to allow rotation
- 25mm thick Glidcop “jaw” brazed to mandrel
 - 20 “20mm wide facets” 25um flat are the collimating surfaces
- Molybdenum shaft with 2mm “heat expansion gap” from mandrel
 - Mandrel held at midpoint only by a brazed Glidcop “hub”

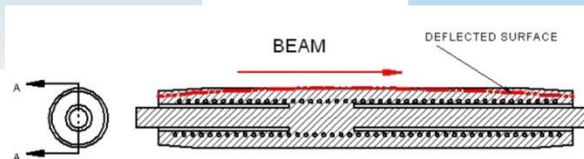
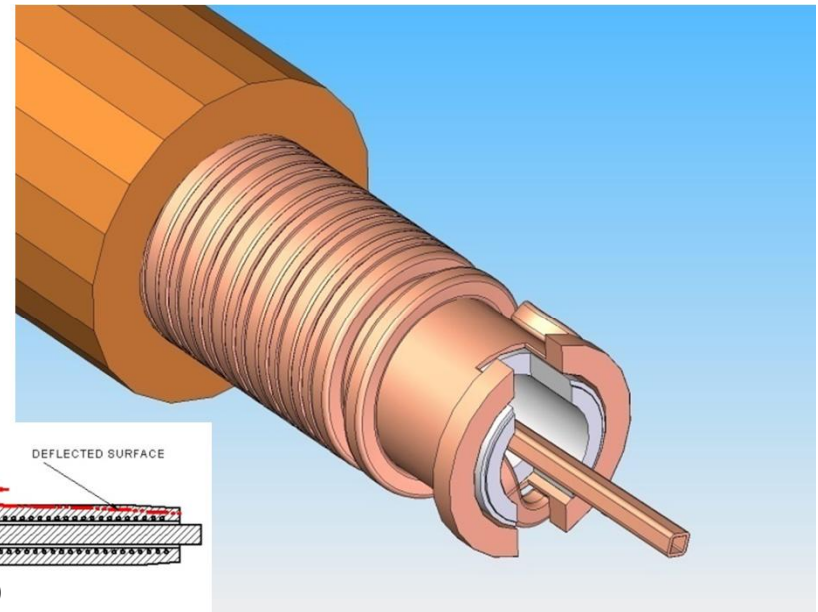
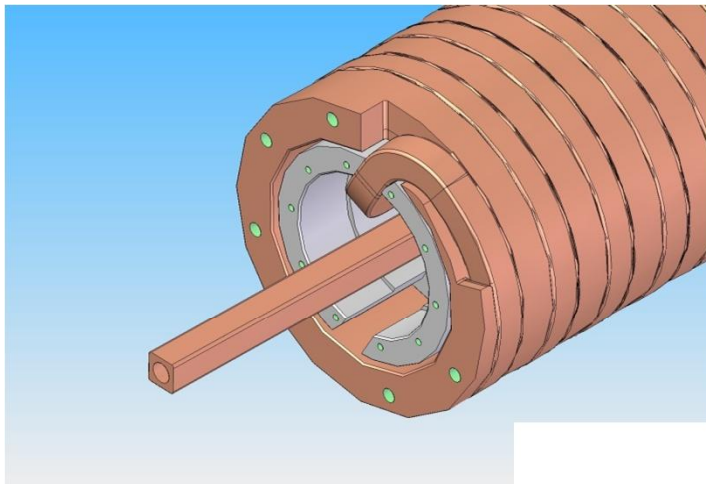
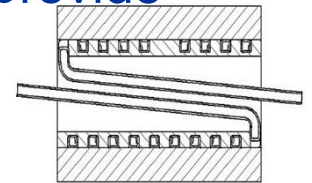

LHC Phase II Base Concept

Glidcop Jaw - Cu Mandrel wrapped with CuNi coil – Hollow Glidcop Hub / Molybdenum Shaft with 2mm gap from Mandrel

- Beam spacing → 136mm OD/jaw
- Length 1.47 m flange–flange:
 - 930mm overall
 - 2 x 38mm 15° tapers
 - 854mm long facets

Helical cooling channels 23mm below surface with 16m long 10mm square CuNi tube

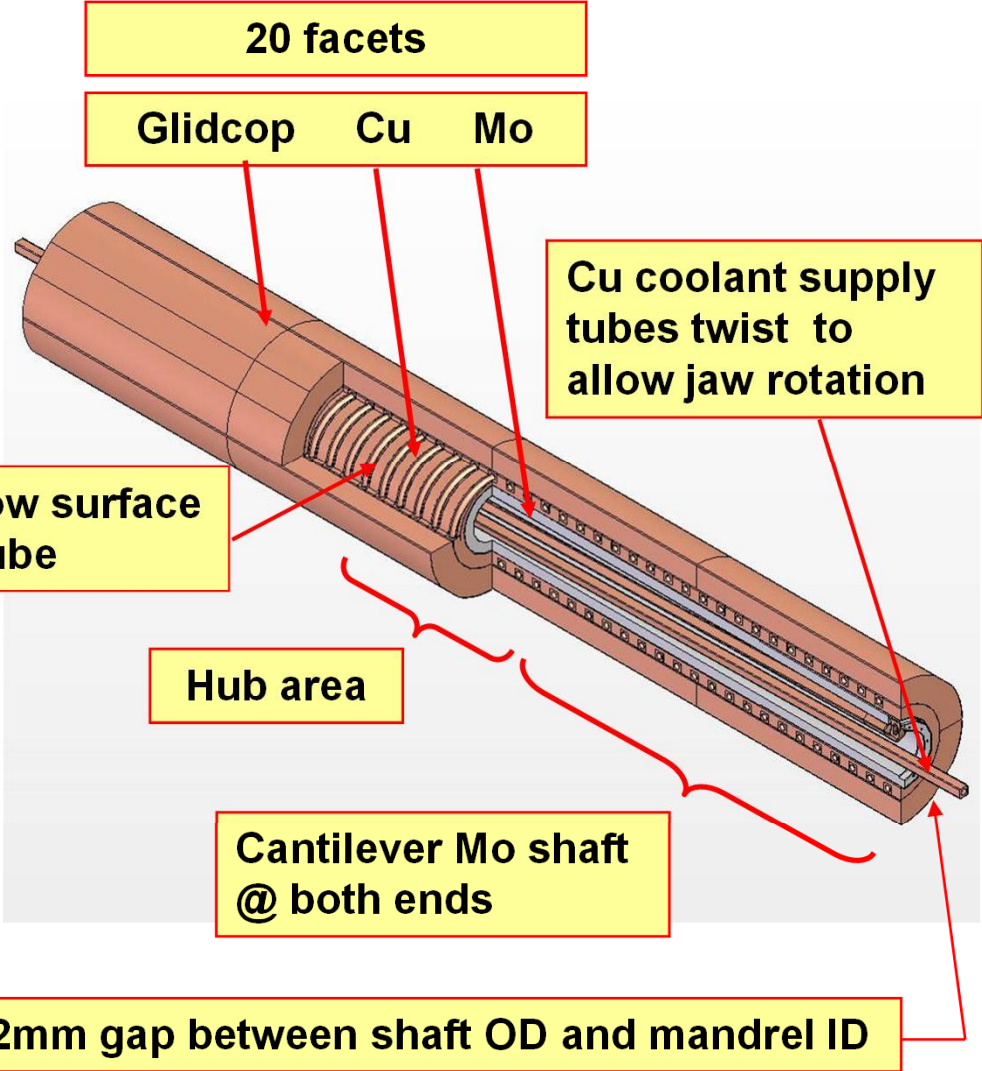

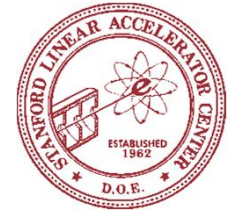

Glidcop Jaw – CuNi Coil- Cu Mandrel – Glidcop Hub - Molybdenum Shaft Design

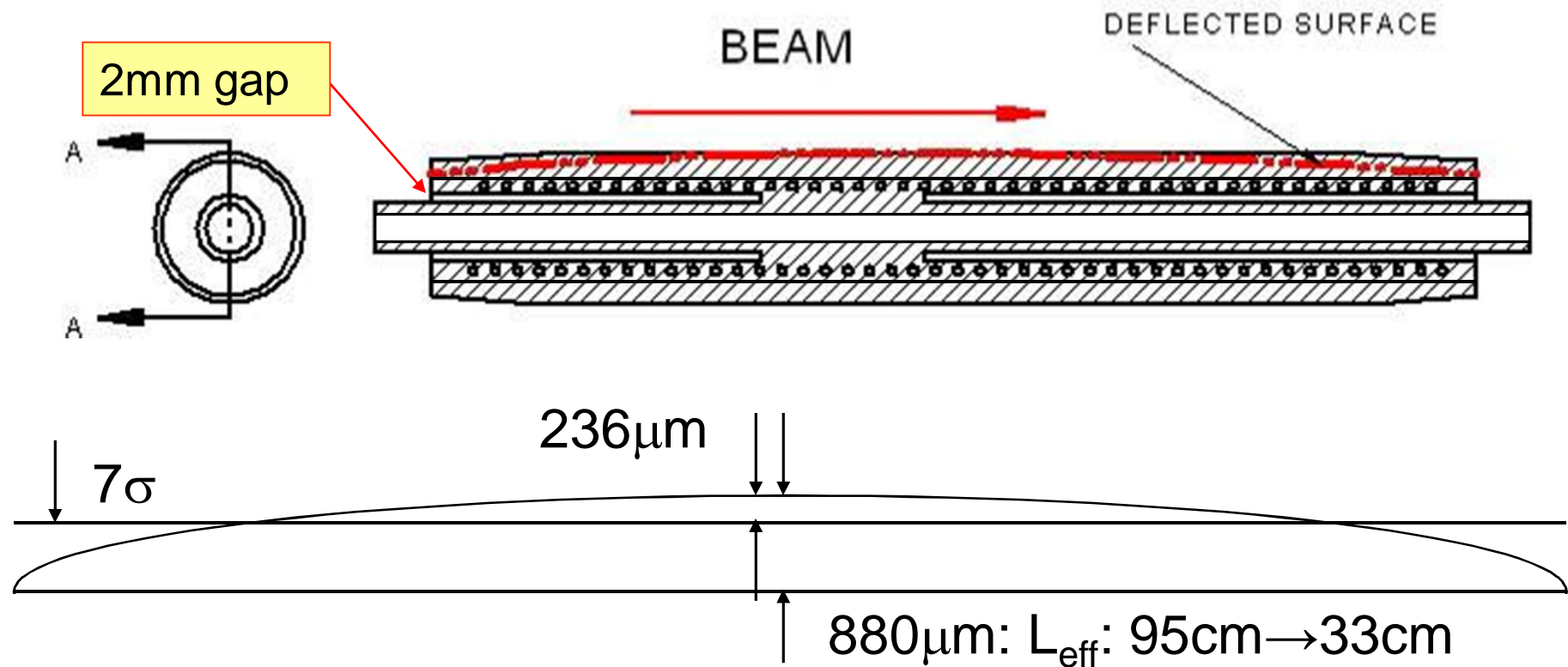

ANSYS calculation of **thermal distortion of when jaw
absorbs 60kW for 12 seconds**
Figure of merit to evaluate materials & design details

FLUKA Results - Power Deposited vs. Length

- 1st secondary collimator
- Various materials

kW Deposited in TCSM.A6L7 Upper Right Jaw vs. Length

80% halo on TCPV, 5% halo on TCSM.A6L7, 12 min. lifetime

half-gaps = 10σ unless noted

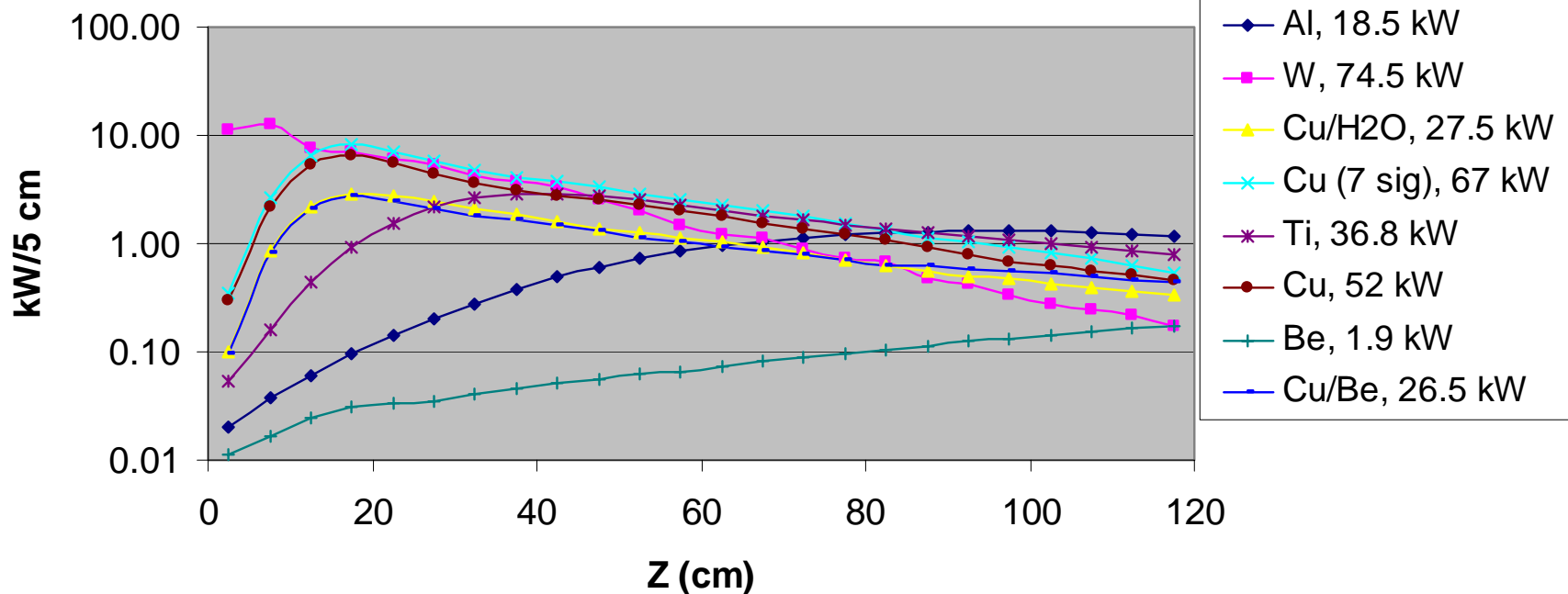

Material thermal performance

- Hollow Cylinder Model before 2mm gap introduced
- O.D = 150 mm, I.D. = 100 mm, L = 1.2 m
- NLC-type edge supports
- aperture 10σ

10 σ , primary debris + 5% direct		SS @ 1 hour beam life					transient 10 sec @ 12 min beam				
material	cooling arc (deg)	power (kW) per jaw	Tmax (C)	defl (um)	Tmax water side(C)	max flux (W/m^2)	power (kW)	Tmax (C)	defl (um)	Tmax water side(C)	max flux (W/m^2)
Al	360	3.7	33	143			18.5	73	527		
2219 Al	360	4.6	34	149	26	7.1E+04	23	79	559	46	3.1E+05
BeCu (94:6)	360	0.85	24	20			4.3	41	95		
C R4550	360	0.6	25	5			3.0	41	20		
Cu	360	10.4	61	221	43	2.7E+05	52	195	829	117	1.2E+06
Cu - 5mm	360	4.5	42	117	39	2.3E+05	22.4	129	586	117	1.2E+06
Cu/Be (5mm/20mm)	360	5.3	53	161							
Super Invar	360	10.8	866	152 ¹	60						
Inconel 718	360	10.8	790	1039	66		54	1520	1509	85	
Titanium	360	7.4	214	591	42		36.8	534	1197	77	
Tungsten (.48 m L)	360	13.5	183	95	79		67.5	700	335	240 ²	2.6E+06
Al - solid core	36	3.7	40.8	31			18.5	80	357		
2219 Al		4.6	43	31			23	89	492		
BeCu (94:6) *		0.85	27	2			4.3	46	101		
Cu		10.4	89	79	67	5.6E+05	52	228	739	139	1.4E+06
Cu - solid core		10.4	85	60	65	5.3E+05	52	213	542	120	1.2E+06

1. deflection not valid, super invar loses its low c.t.e. at 200C
2. pressure > 30 bar needed to suppress boiling

* Promising but no practical implementation

Cu chosen – balance of efficiency, deflection and manufacturability



Comparison of Sagitta & Temperature with ANSYS as a function of angle with respect to heater

- Jaw with two 5 kW heaters modeled
- Includes accurate representation of
 - Water flow/temp change
 - Material properties
 - Thermal expansion
 - Heat flow / thermal conductivity
- Data ~10% larger than ANSYS

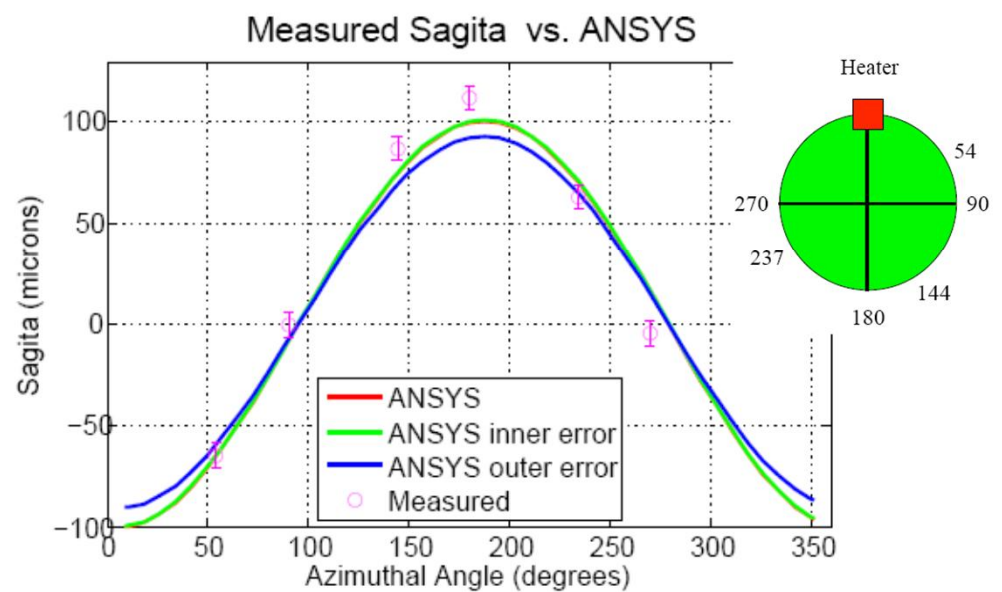
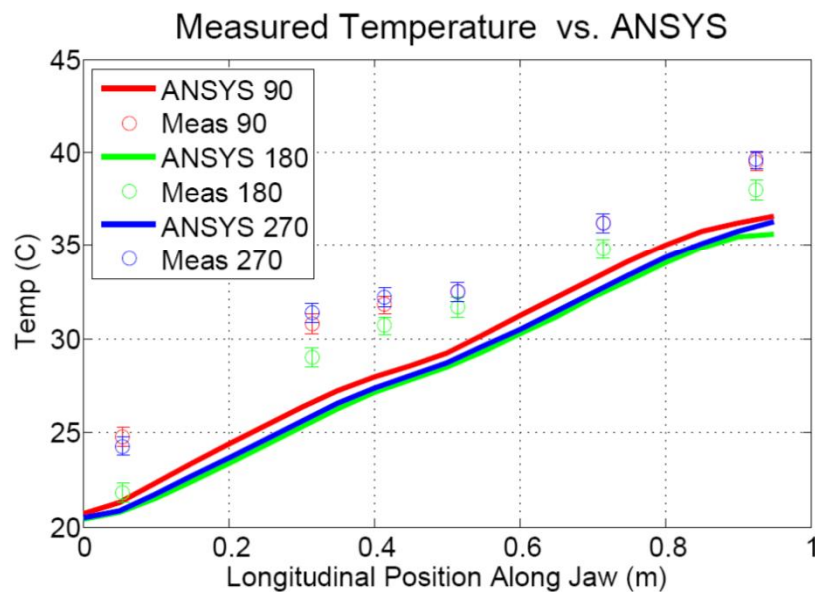
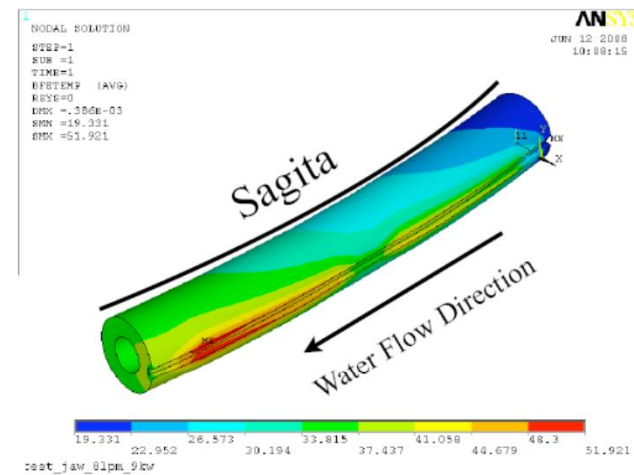

Rotatable Design: Asynchronous Beam Abort

In asynchronous beam abort onto any collimator:

Cu absorbs 27% beam energy vs. 3.6% for C

- Cu heated \gg melting temperature
- Shock wave may permanently deform material



Relevant Considerations:

- Facet width of RC=20.25mm contains fracture
- Melt zone ($T > 1080^\circ\text{C}$) is 30cm long, centered on shower max $\sim 20\text{cm}$, with radius 3.3mm (\sim collimator gap)
- Fracture zone ($T > 200^\circ\text{C}$) is $\sim 7\text{mm}$ radius, $\sim 1/3$ of distance to water coil
- Water $\Delta T \sim 1.5^\circ\text{C}$ with resultant $\Delta P \sim 6\text{ bar} \ll$ yield strength of copper
- **Disposition of molten material problematic** 
 - Orientation dependent: **vertical dripping**, opposite jaw at risk as well
 - Horizontal collimators #5 & #11 predominately at risk
- Permanent deformation from shock $\sim 50\mu\text{m}$ (away from beam)
- Opposite jaw $\sim 3\text{mm}$ away has $T_{\text{max}} \sim 840^\circ\text{C} < T_{\text{melt}}$
- If 60cm C primary at 6σ struck first (likely?), NO damage to secondary

ANSYS: Beam Abort: 0.27MJ

Constrain jaw ends $t < 200\text{ns}$, then quasi-static stress analysis

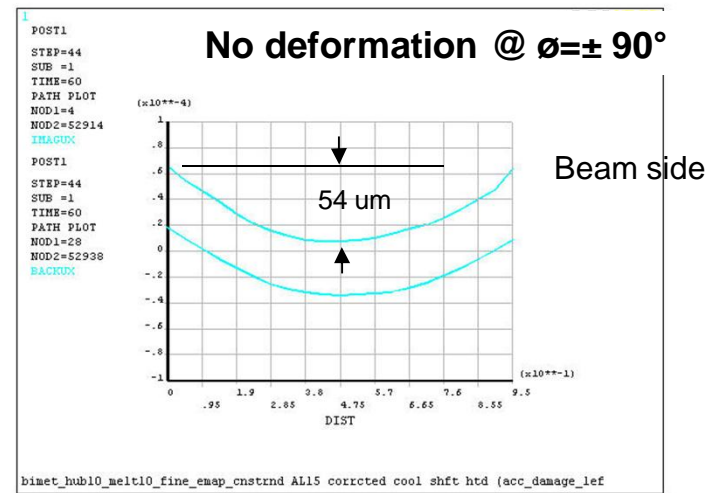
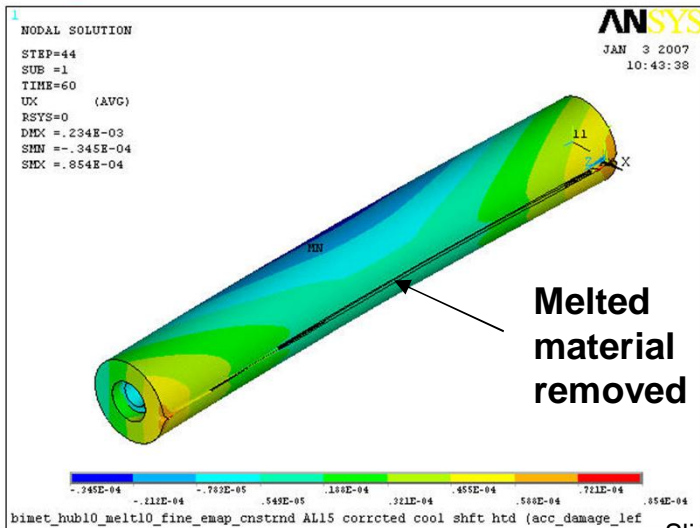
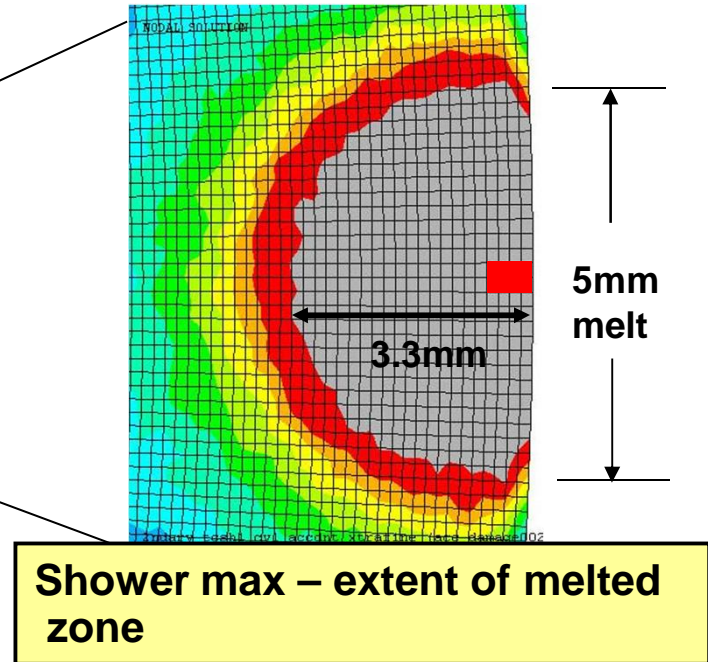
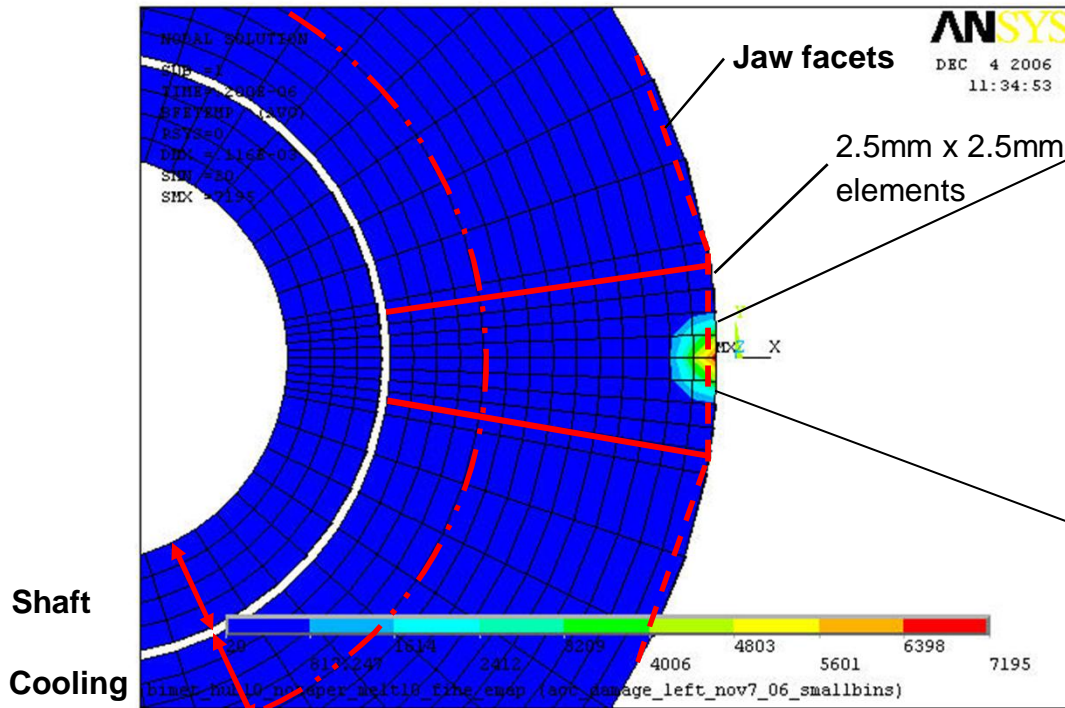

Accident Case

Adjacent Jaw:
At risk

Response if 60cm
Primary Struck First:
No melting

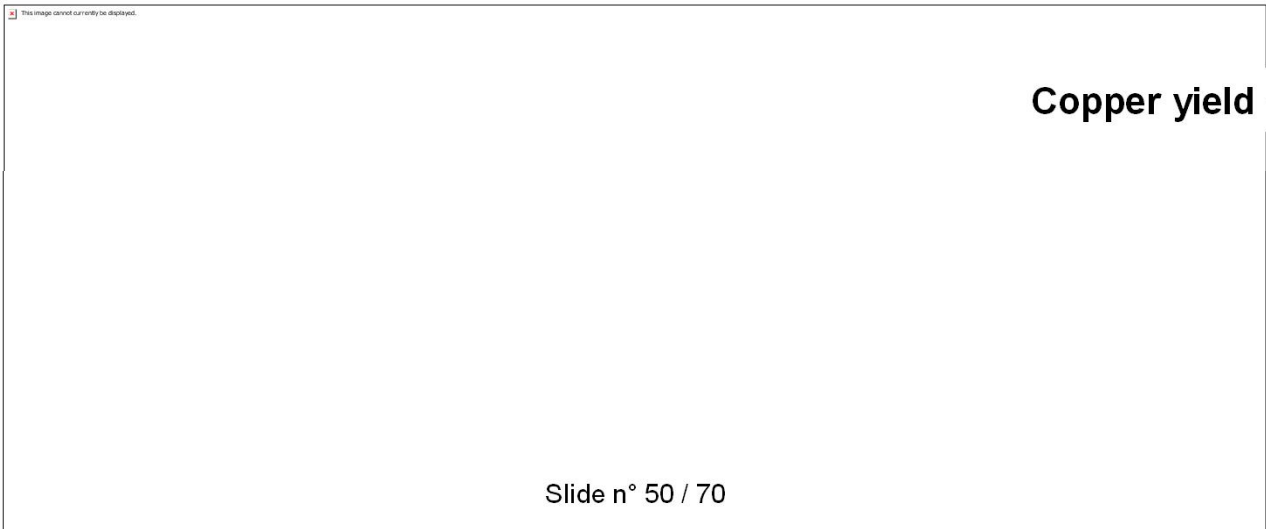
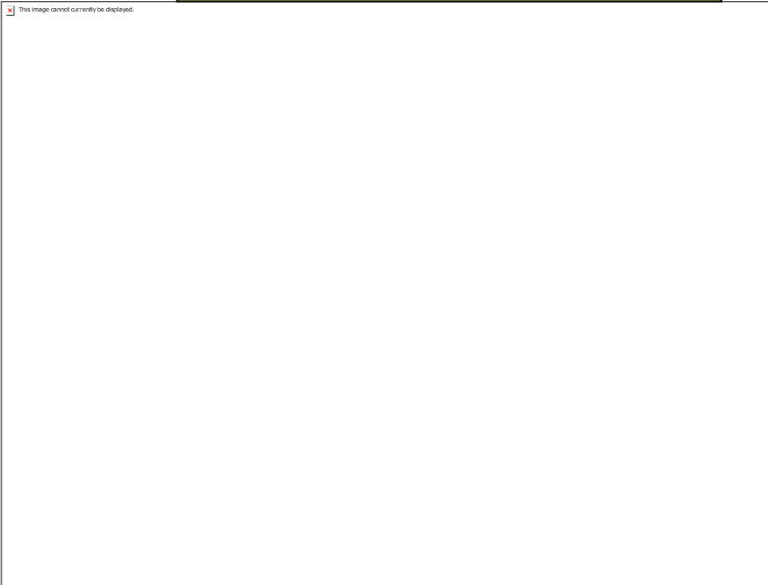
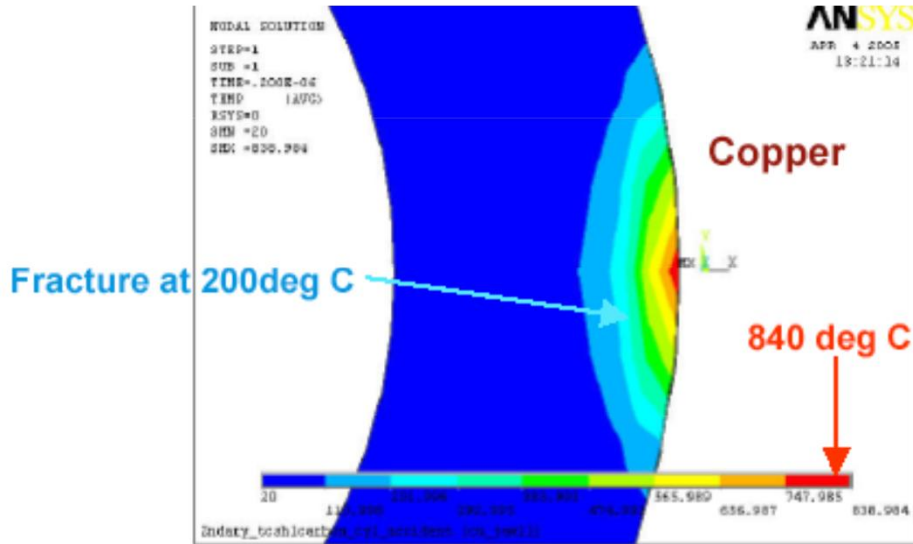

Copper yield ~ 300 bar

Prototype Collimator Assembled 18-Sept-13 Mechanical & Resistance Tests Good

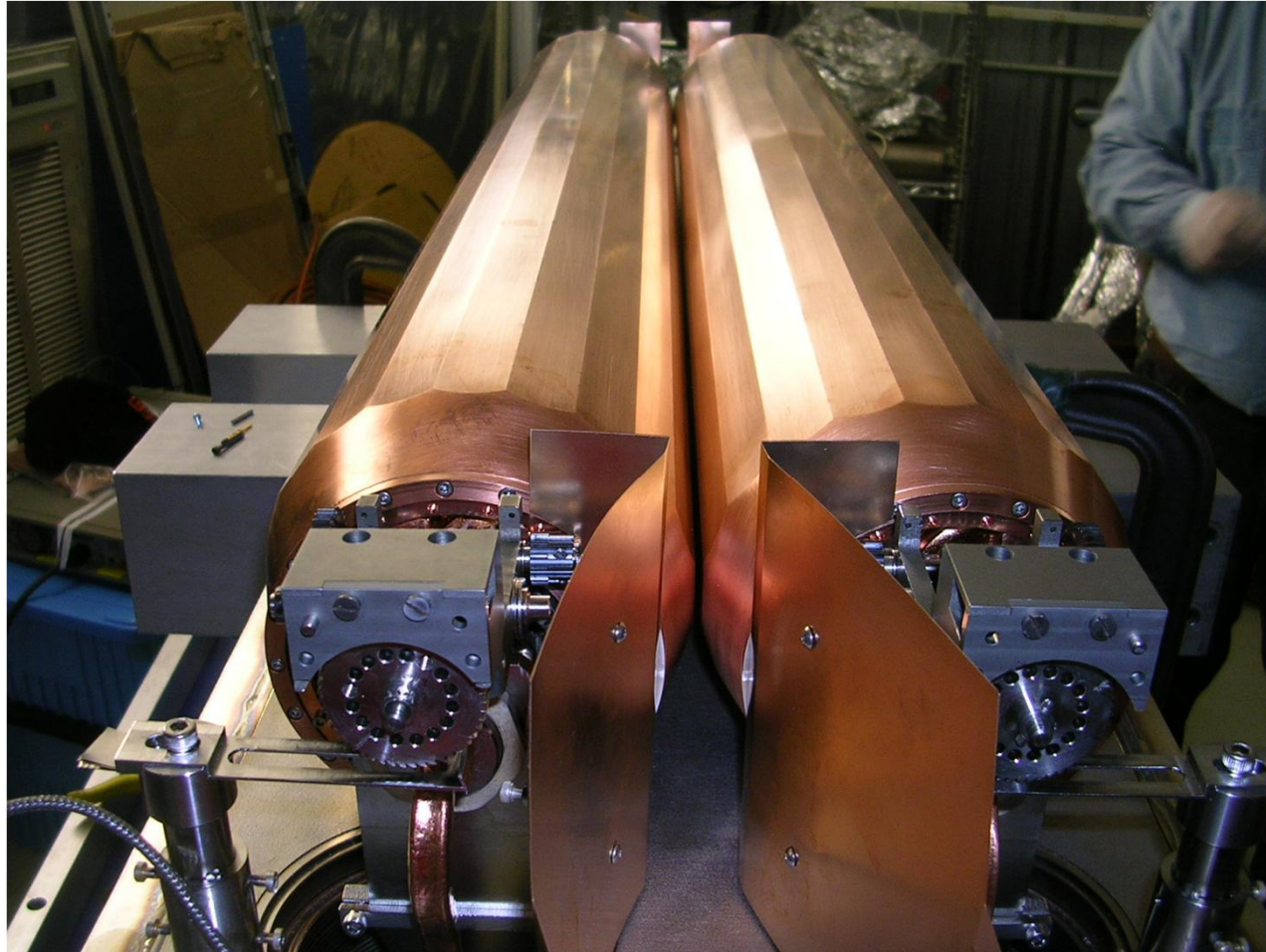

Main Rotation Bearing and “RF Bearing” Which Allows RF Shield to Stay in Place While Cylinder Rotates

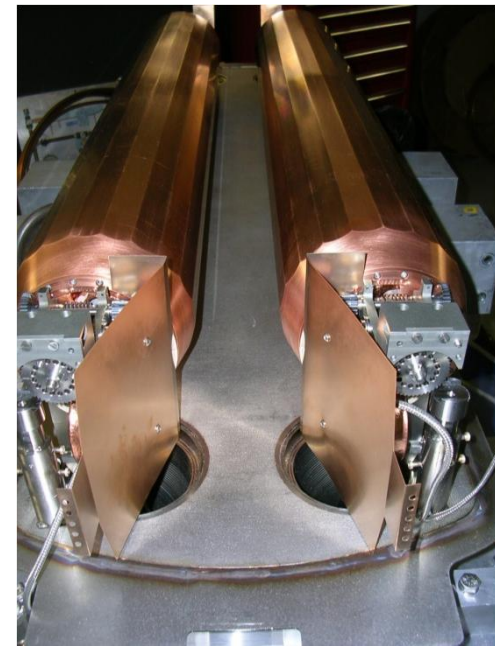
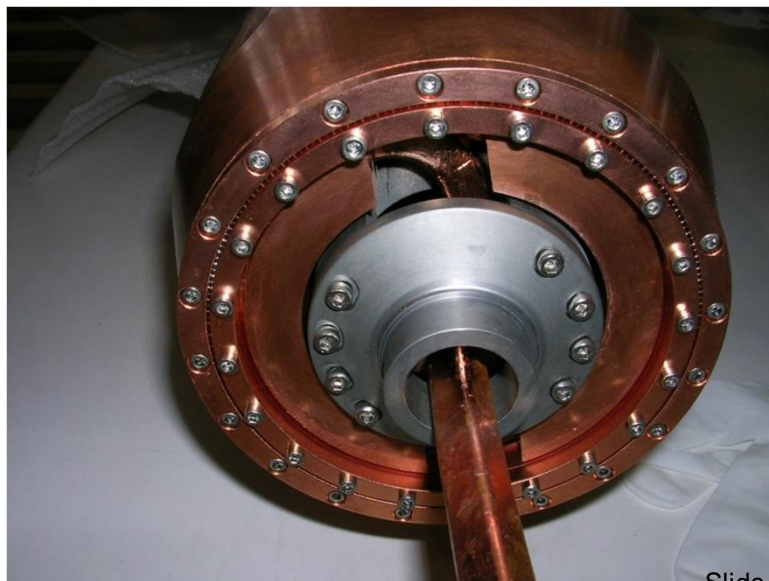
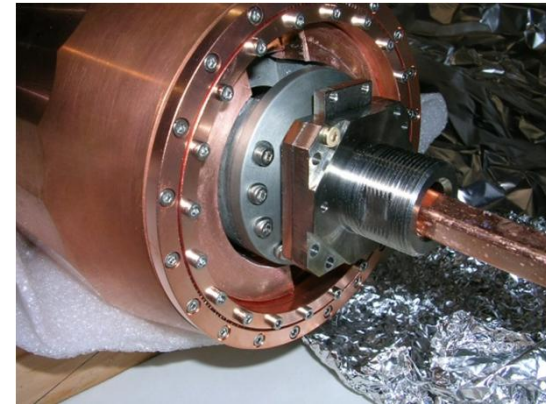
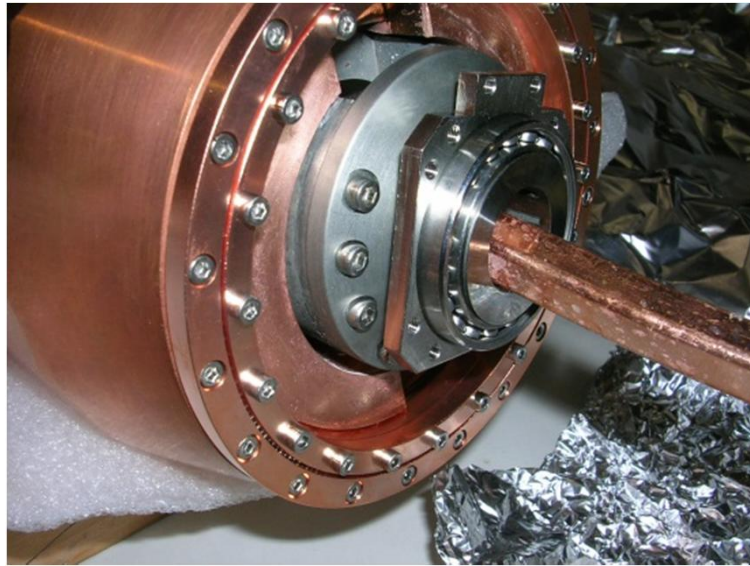

Flexible Shaft Holds Bearing Housing
Shaft Translates Using Standard LHC Motors System
Gear Mechanism to Drive Rotation Mounts to Main Bearing Housing
Fixed Claw drives Toothed Wheel & Gear Box Drives Worm Gear to
Turn Collimator

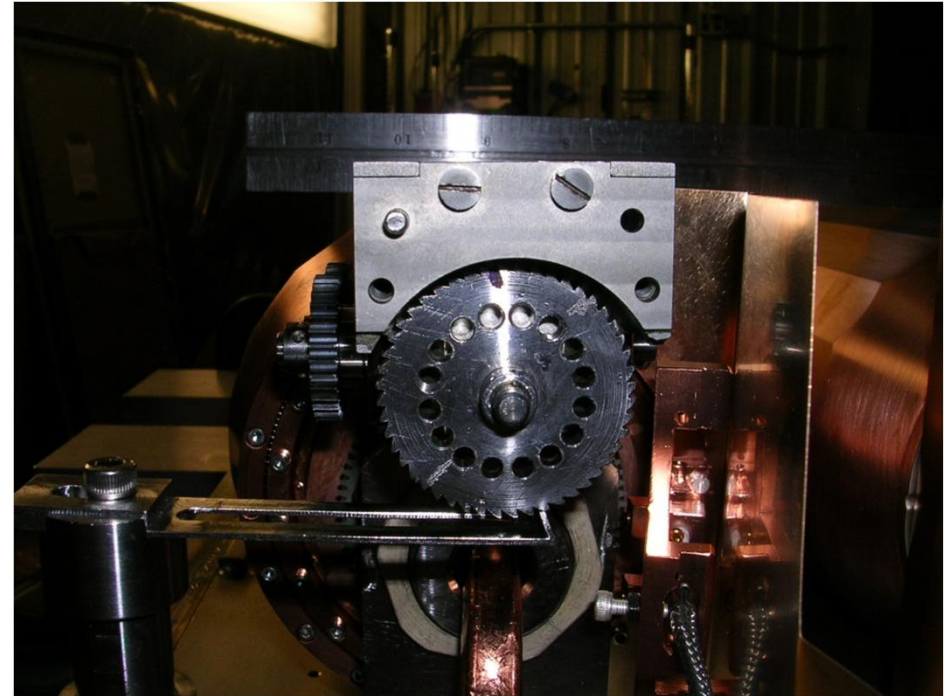
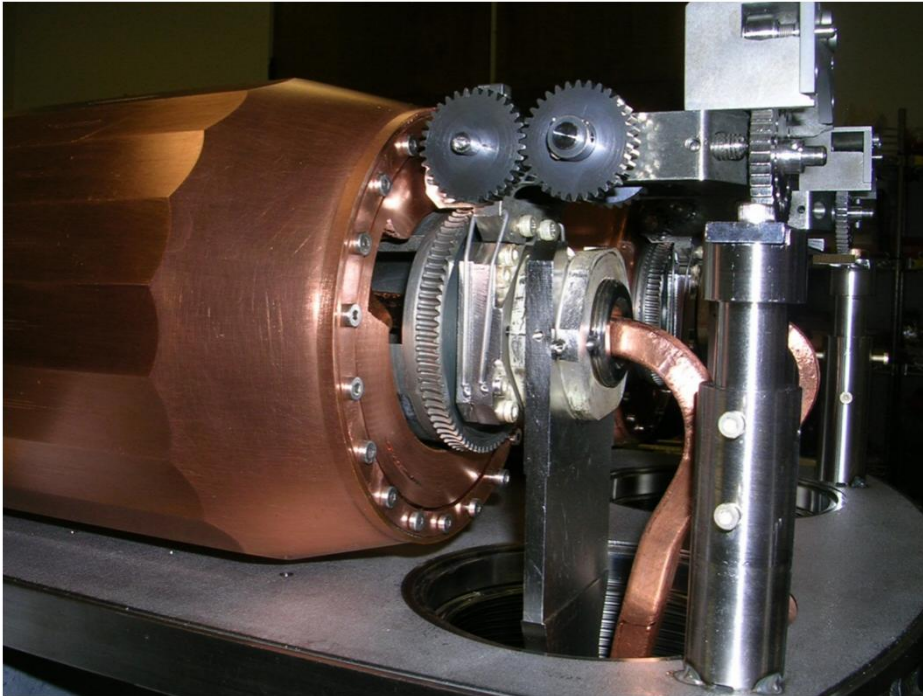

Prototype on test stand at CERN with JAS14 Student



Vacuum, 1st round impedance & 2 rounds functional testing complete
Metrology & 2nd round of wire impedance tests planned
SPS Installation & Beam Tests being planned
HiRadMat testing program outlines and beam request made

Collimation with Hollow Electron Beams

Giulio Stancari, A. Valishev (Fermilab)

R. Bruce, S. Redaelli, A. Rossi, B. Salvachua Ferrando (CERN)

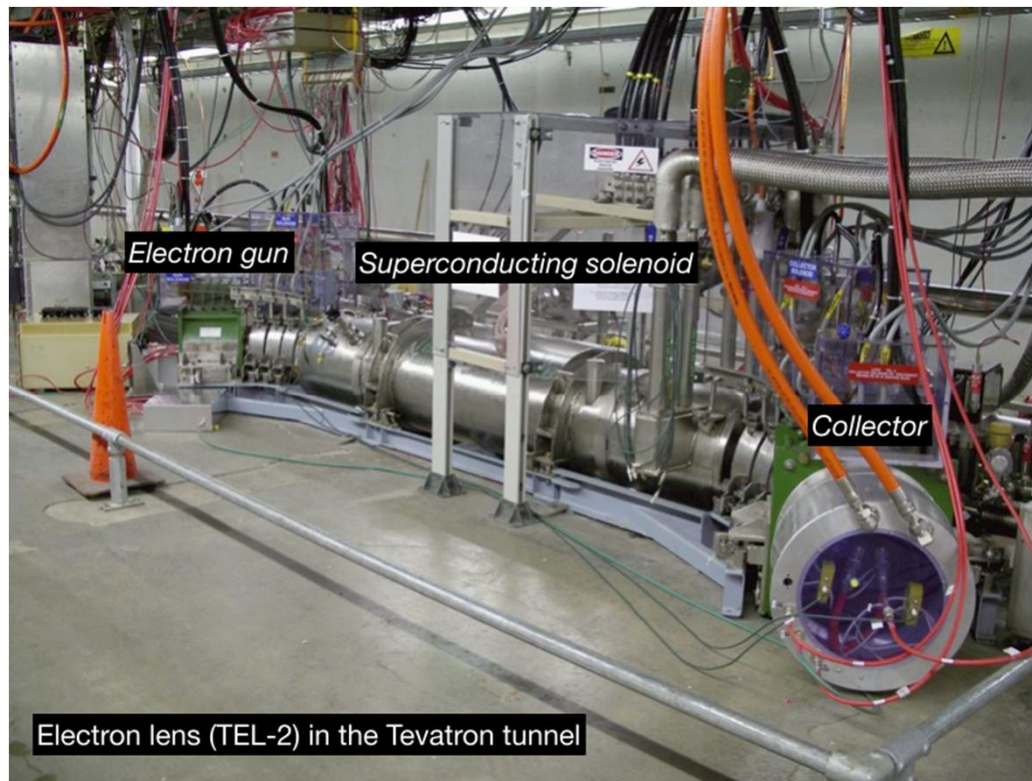

Electron beam current profile shaped by cathode geometry and maintained by strong solenoid field

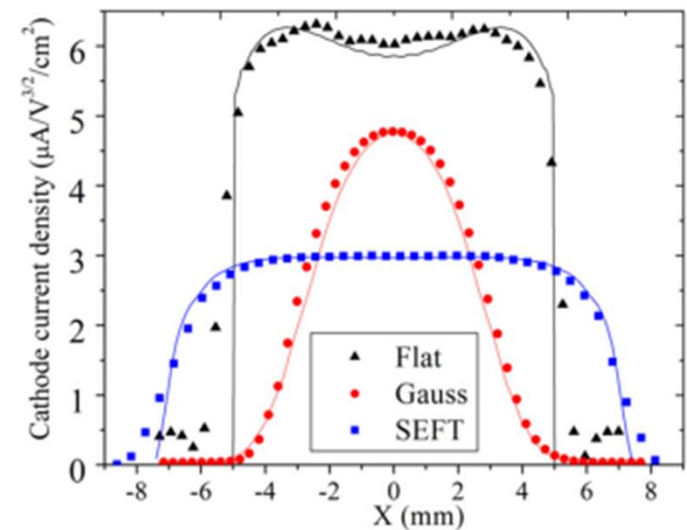

In Tevatron used for:

- Beam-Beam compensation
- Betatron Tune correction
- Abort Gap Cleaning

~2009: Develop Cathode for 15mm Hollow Electron Profile to use E-Lens as a Halo Scraper

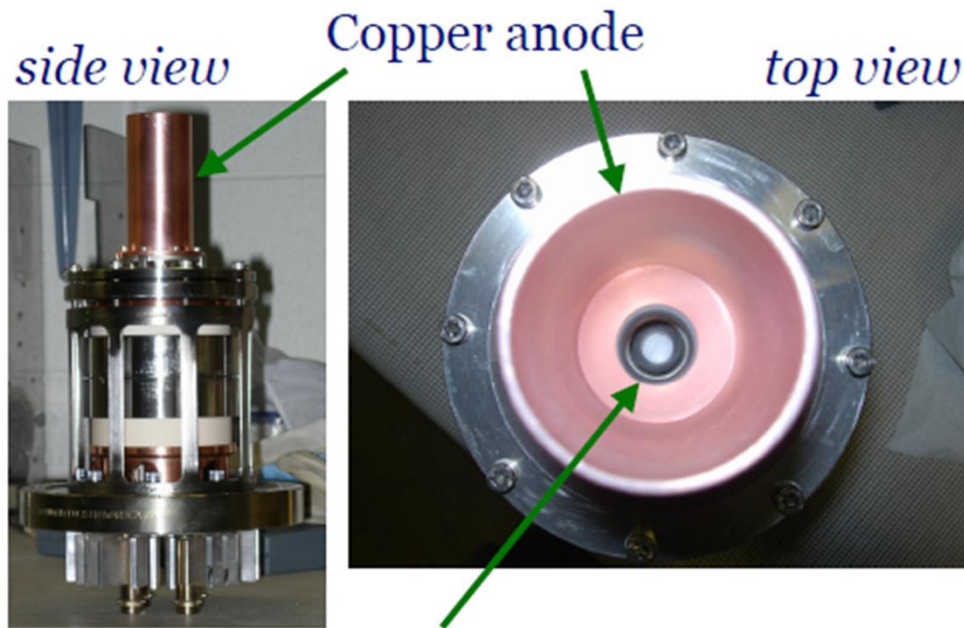

Tungsten dispenser cathode with convex surface
15-mm diameter, 9-mm hole

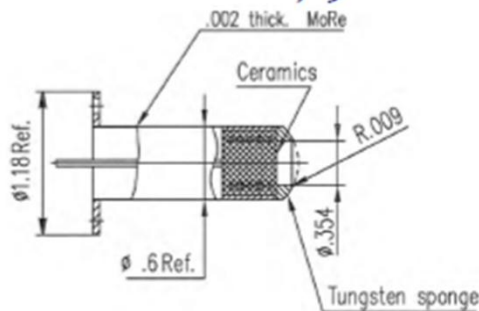

Yield: **1.1 A** at 4.8 kV
Profile measurements

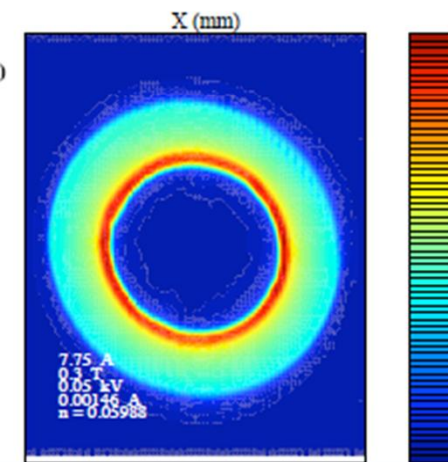
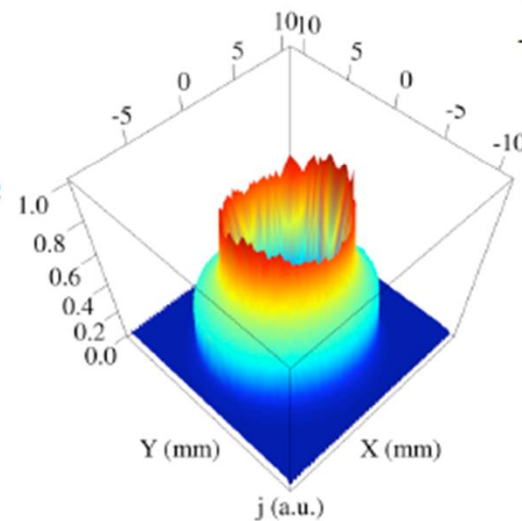
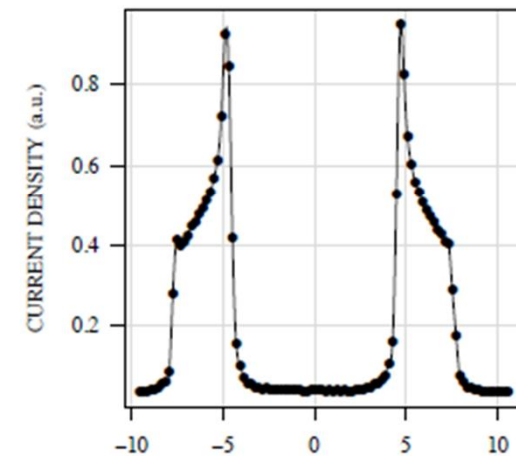

Hollow Electron Beam Gun in Tevatron

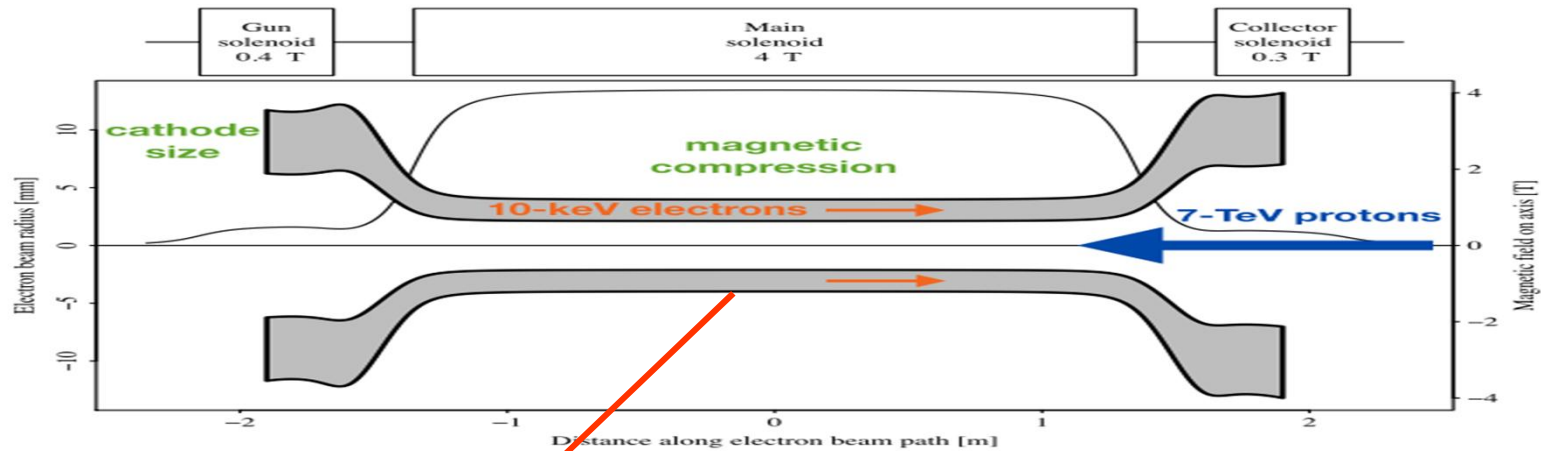

Transverse separation is 9 mm

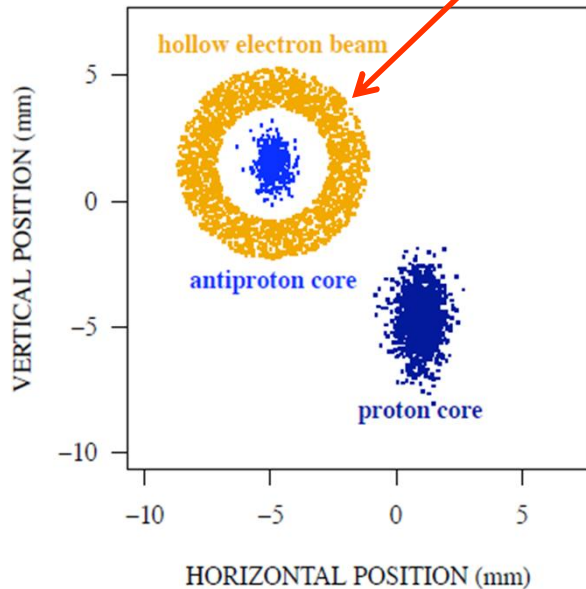

Pulsed electron beam
can be synchronized with
any group of bunches

Main solenoid controls diameter of electron ring

18 experiments 2010.10-2011.06

- Tail of selected bunch depopulated
- Control bunches & core of selected bunch unaffected

Example HEBC Result: Selected & Control Bunch Intensity vs. Beam Size

Excellent progress in understanding of hollow beam collimation
Many new observations: halo removal rates, effects on core, diffusion, fluctuations in losses, collimation efficiencies, ...

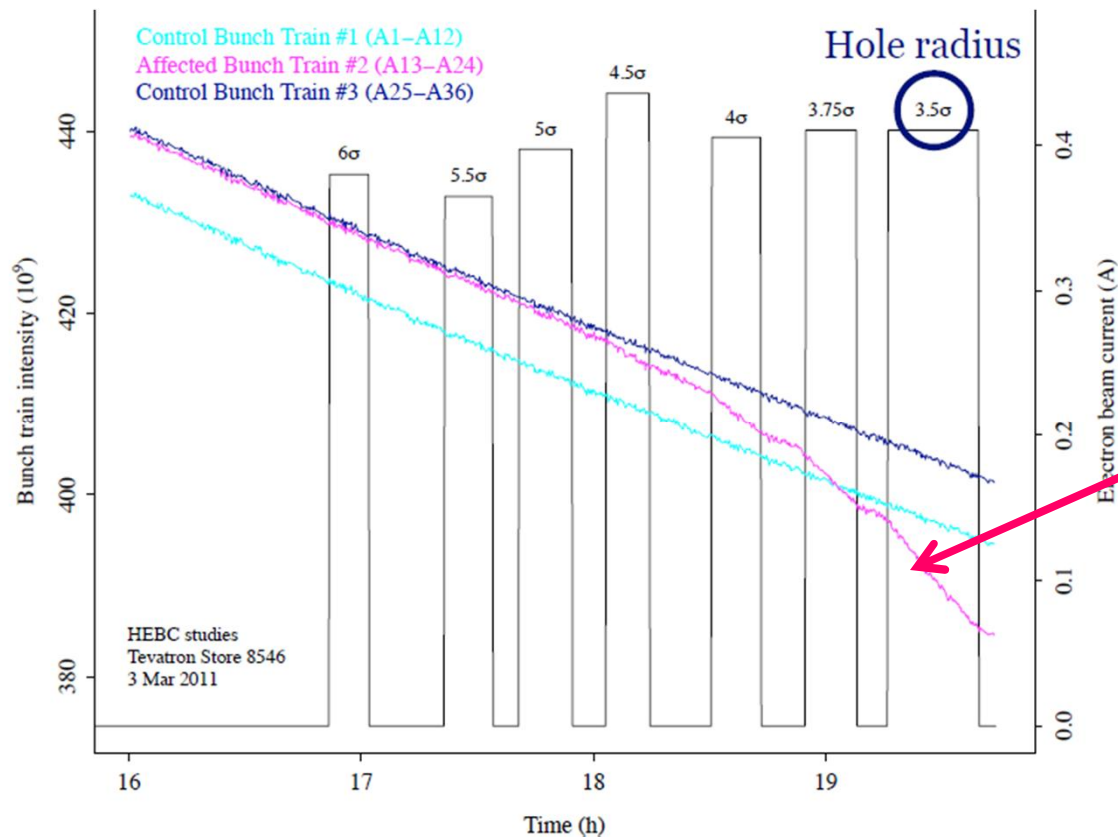

Pulse Gun for synched to one bunch train and look at Intensity decrease as diameter of the electron current ring decreases

Stancari et al., Phys. Rev. Lett. 107, 084802 (2011)
Stancari et al., IPAC11 (2011)
Stancari, APS/DPF Proceedings, arXiv:1110.0144



Integration in multi-stage cleaning

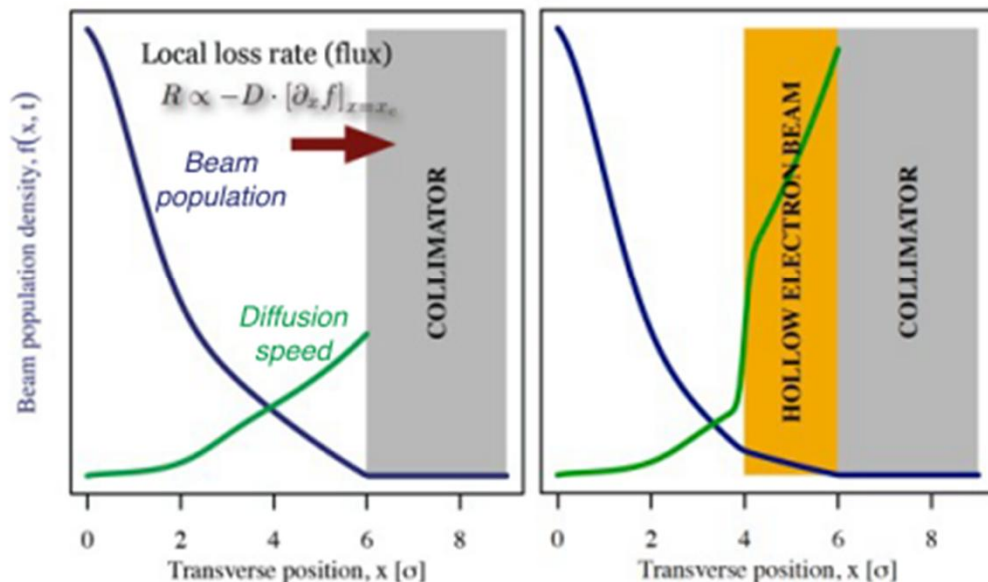
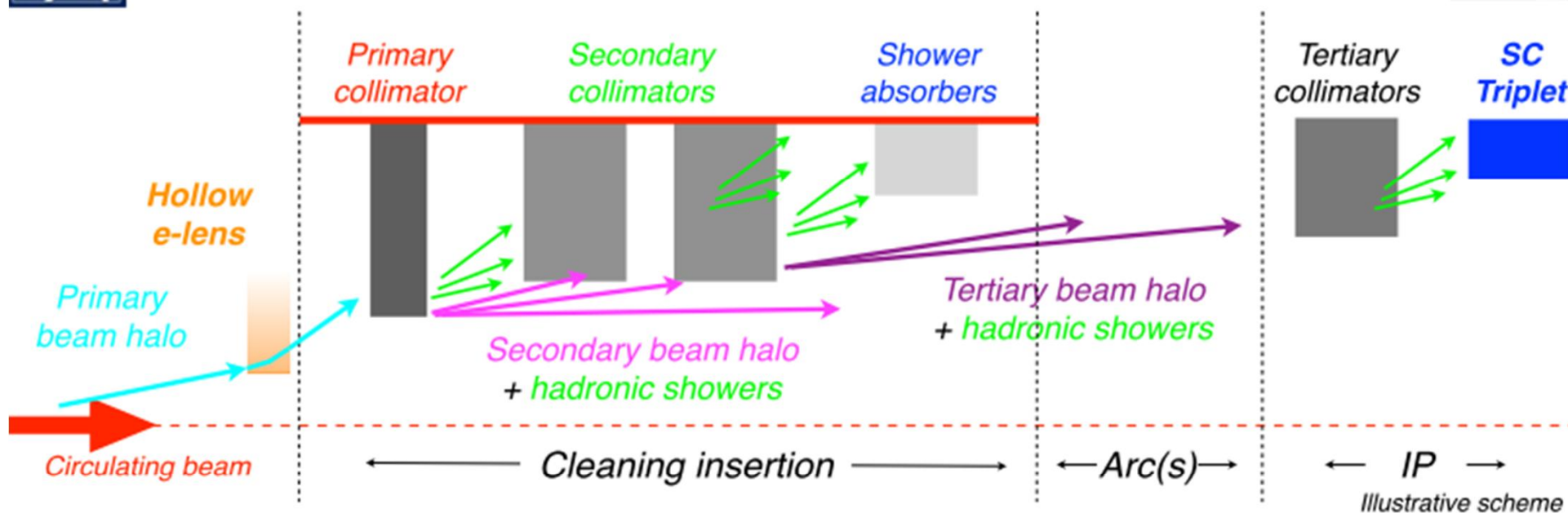

- The classical **multi-stage collimation** concept is maintained.
 - No need to change present hierarchy
- Ensures a full compatibility with present and future schemes
 - E.g., compatible with crystals and also for ions.
- “Hole” around core make losses insensitive to orbit drifts.
- Lens does not need to be in IR7
 - Indeed, it better be elsewhere!

Feasibility for LHC Studied & Conceptual Design Report Written

Candidate location RB-46

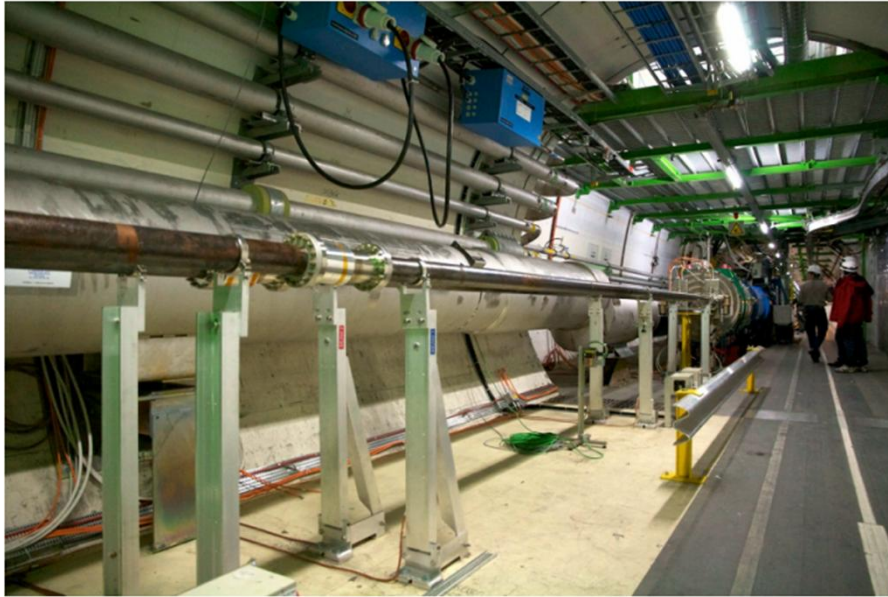

LHC E- Gun Prototype

hollow cathode

copper anode



Mechanical Integration

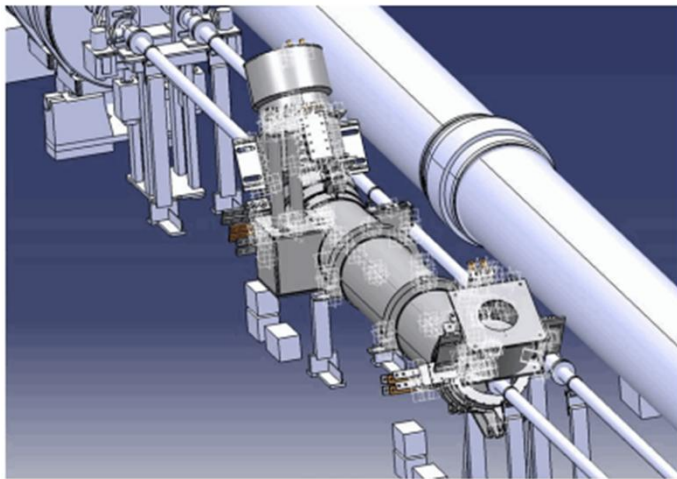

Gun & Collector Opposite to Minimize Inj./Ext. Effects

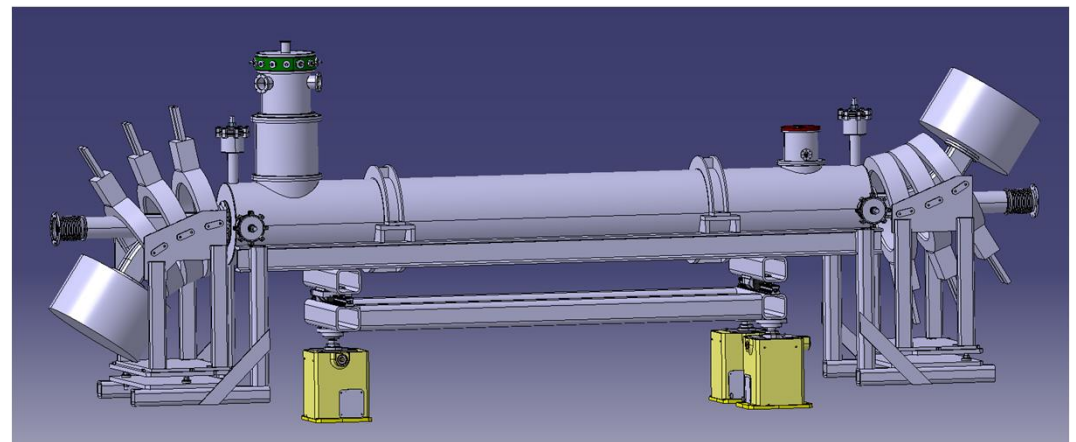

Calculated Halo Removal Rates vs. Electron Current

continuous mode

without collisions

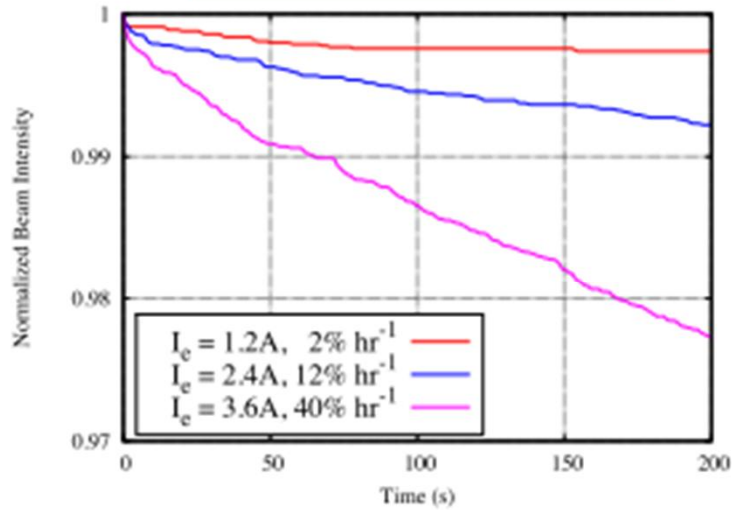

with collisions

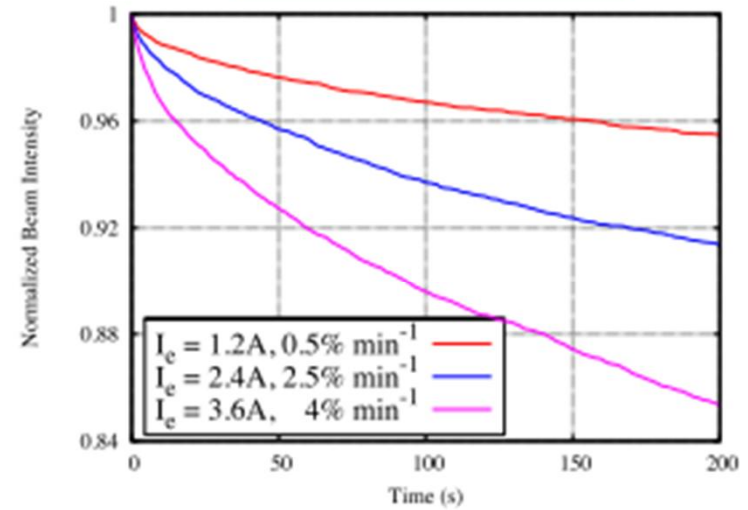

stochastic mode

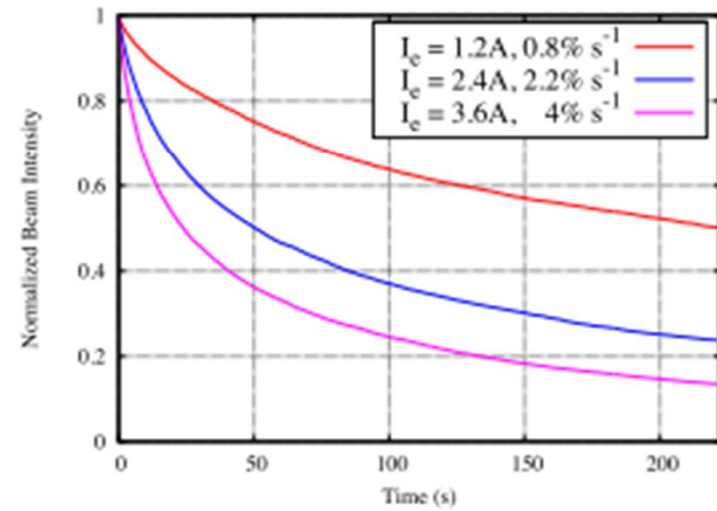
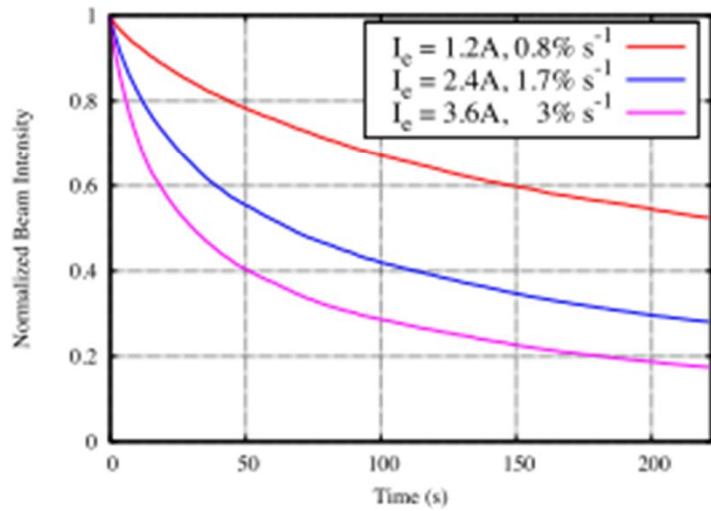

Outlook for a Hollow Electron Beam Scraper for LHC

Next steps

- technical design
- electron-lens test stand at CERN
- beam halo in LHC: machine studies and monitoring techniques
- electron lens and diagnostic studies at RHIC
- alternative schemes
- US LARP and US-HL-LHC contributions
- collaborations, personnel exchanges

Resources required if decision to implement is made

- Construction cost of 2 devices for the LHC (1 per beam) is about 5 M\$ in materials and 6 M\$ in labor
- Construction in 2015-2017 and installation in 2018 is technically feasible
- Reuse of some Tevatron equipment is possible (superconducting coil, resistive solenoids, electron guns, ...)

R&D on Using Bent Crystals as Primary Collimators for LHC

Purpose: Increase collimation efficiency driving halo directly into secondary collimators and absorbers rather than via multiple passes through amorphous solid

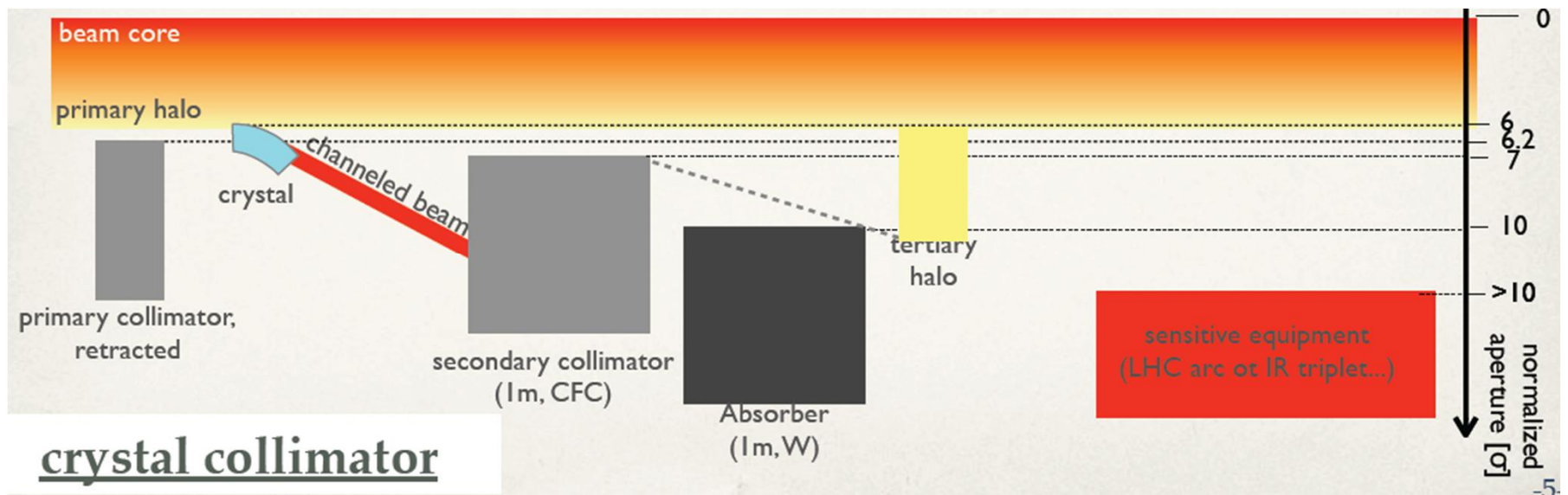

$\langle \theta \rangle_{\text{MCS}} \sim 3.4 \mu\text{rad}$ (7 TeV) in 60cm CFC

$\langle \theta \rangle_{\text{crystal}} \sim 40\text{-}50 \mu\text{rad}$ (7 TeV)

Years of experience in UA9 (SPS) & H8 (NA) tests have led to a test setup installed in LHC

Particle-crystal interaction

Possible processes:

- ◆ multiple scattering
- ◆ **channeling**
- ◆ **volume capture**
- ◆ de-channeling
- ◆ *volume reflection*

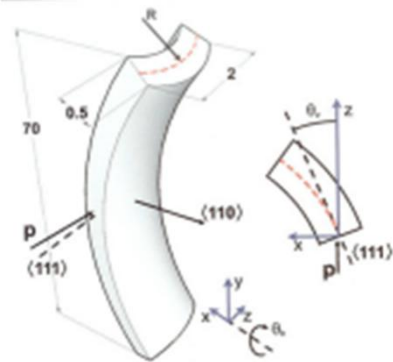
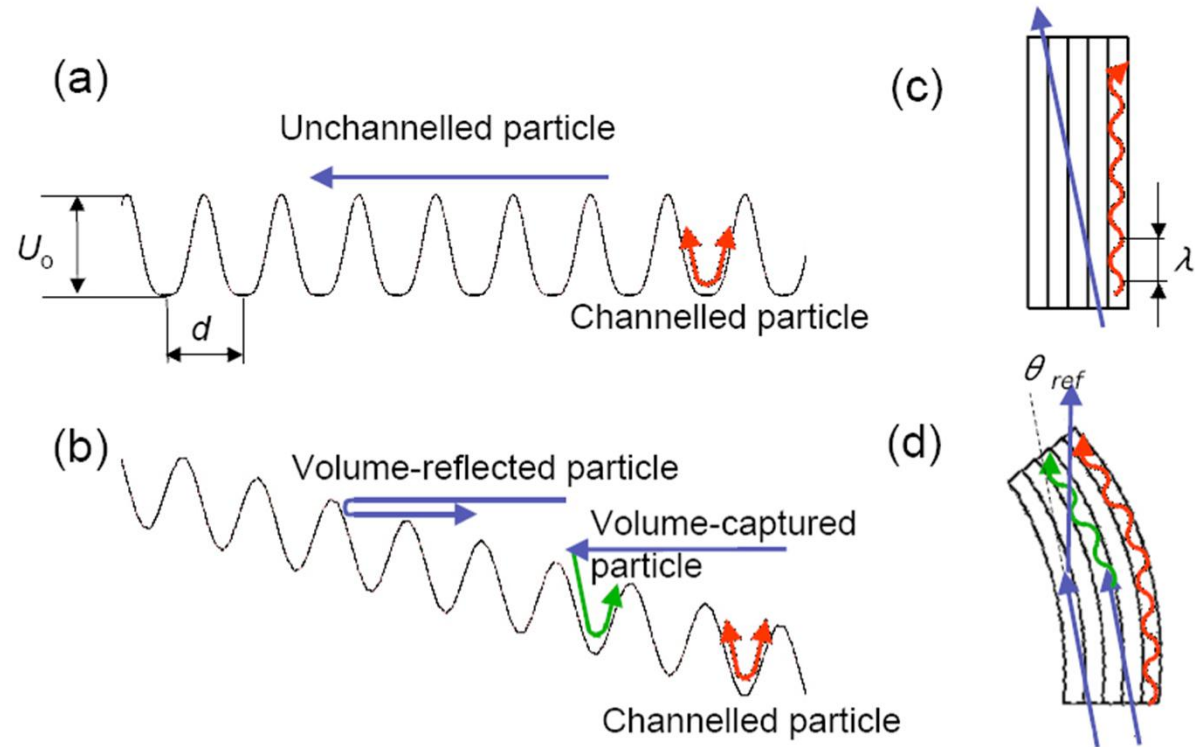

Volume reflection

Prediction in 1985-'87 by
A.M.Taratin and S.A.Vorobiev,

First observation 2006 (IHEP - PNPI -
CERN)

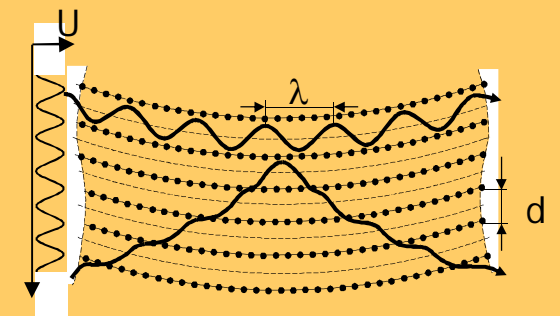

Angular beam profile as a function of the crystal orientation

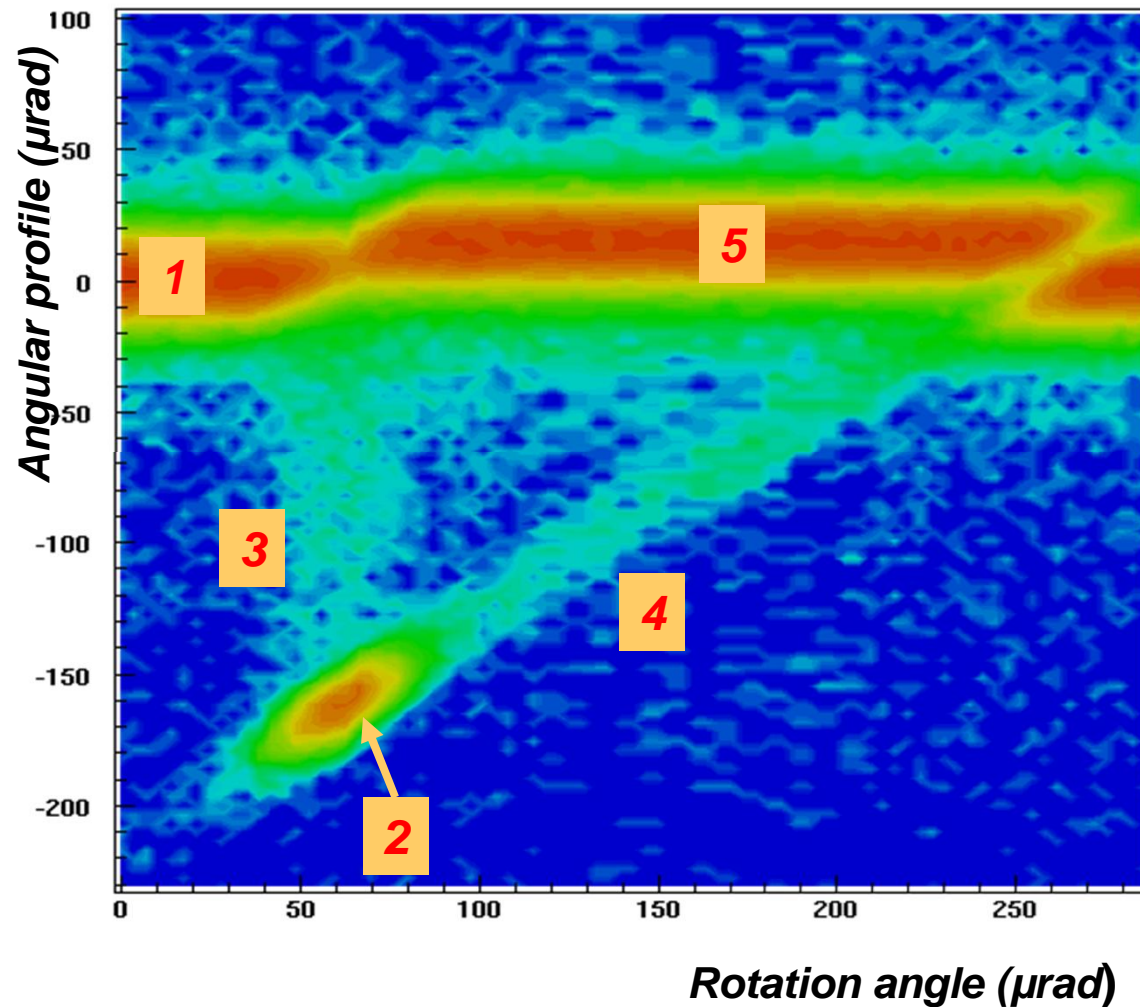

The angular profile is the change of beam direction induced by the crystal

The rotation angle is angle of the crystal respect to beam direction

The particle density decreases from red to blue

- 1 - "amorphous" orientation
- 2 - channeling
- 3 - de-channeling
- 4 - volume capture
- 5 - volume reflection

Example of Angular Scan of a Crystal in Channeling Mode at UA9

Showing Reduction of Halo Signal in 3 detectors
as Crystal Sweeps Channeled Halo Away

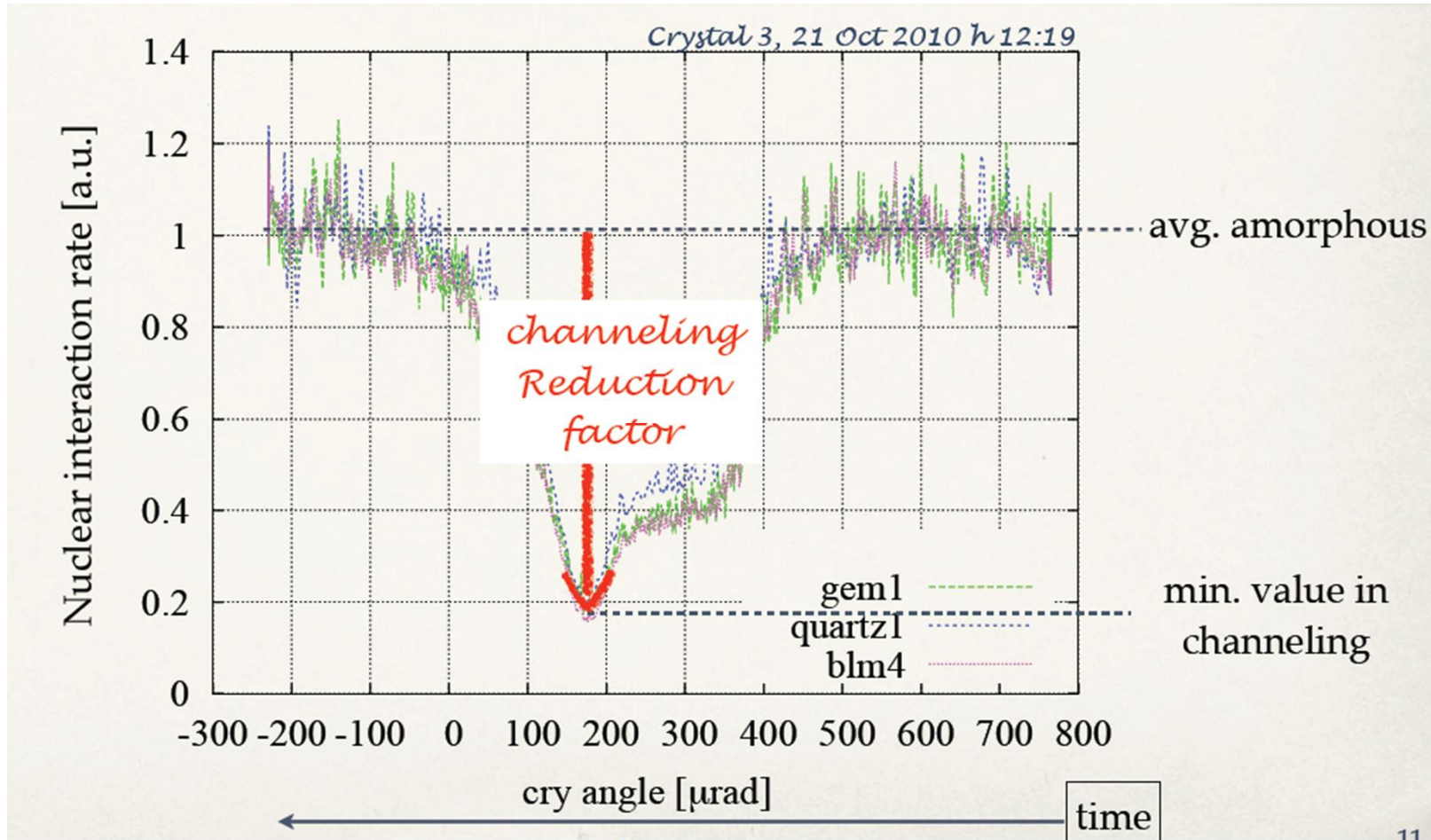

Digression: 6.3 GeV e- in 60 μ m/400 μ rad Bent Crystal Studies at SLAC

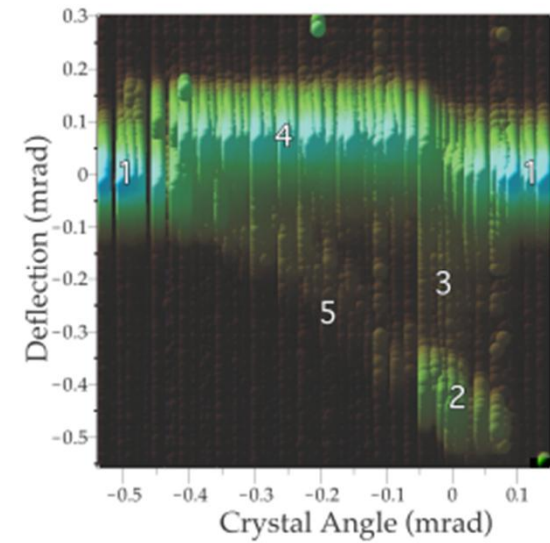
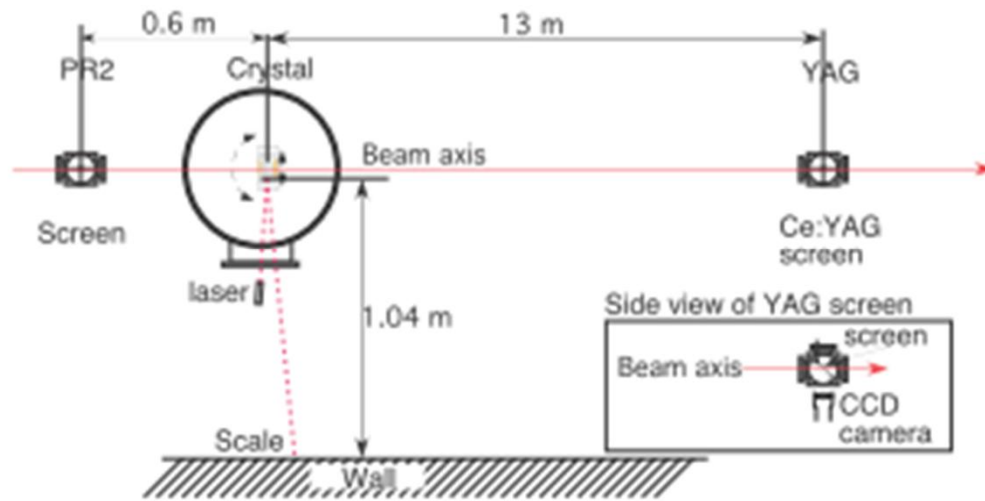

Volume Reflection

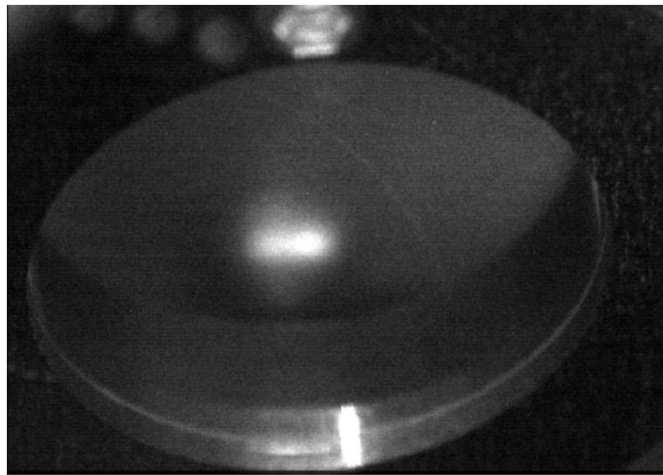

Channeling

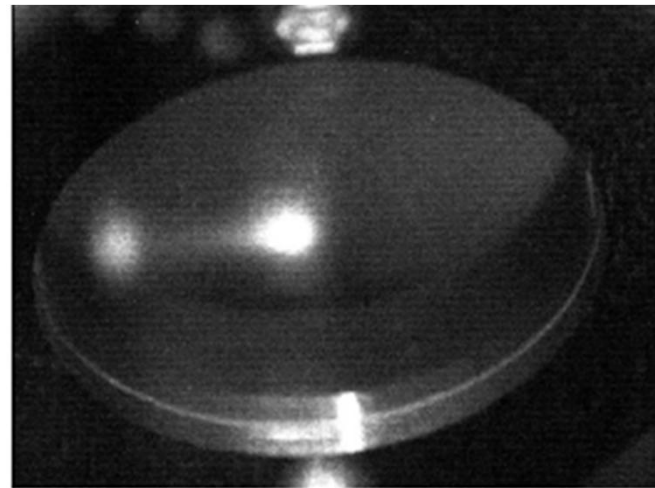

H and V Goniometers Installed in IR7 for Low Intensity Channeling Tests in LHC Post LS1

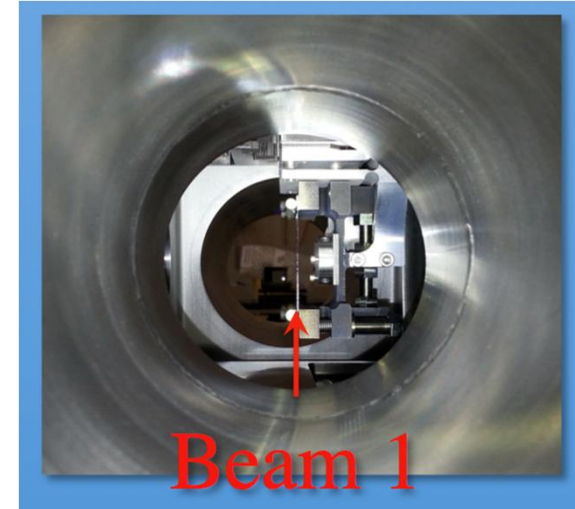
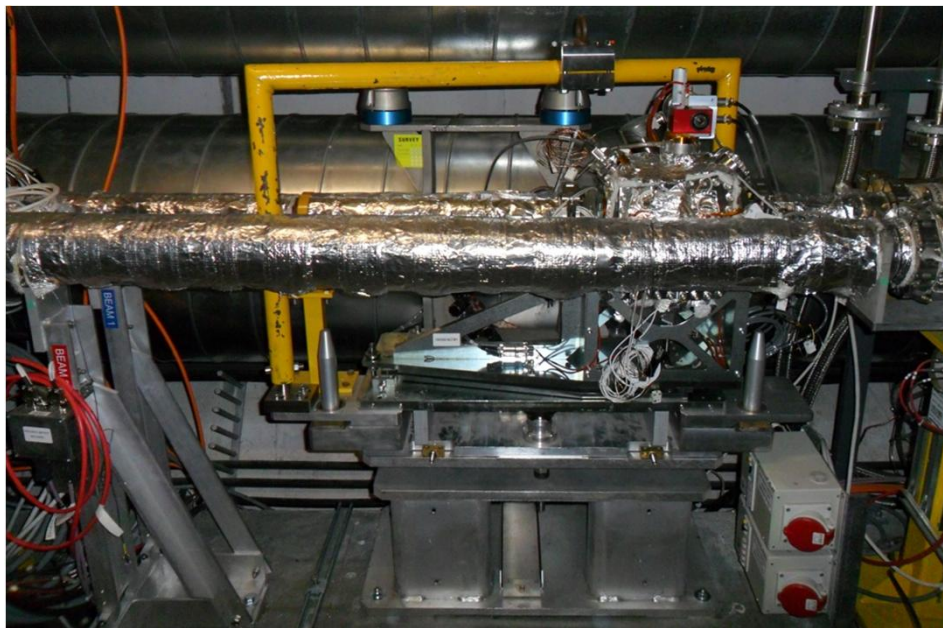
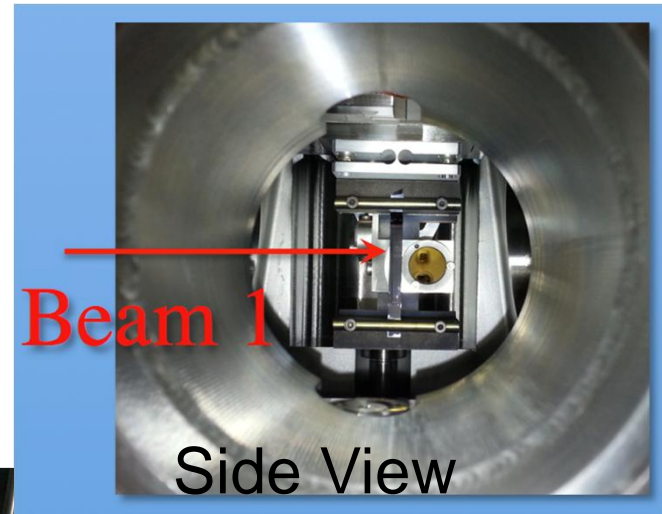
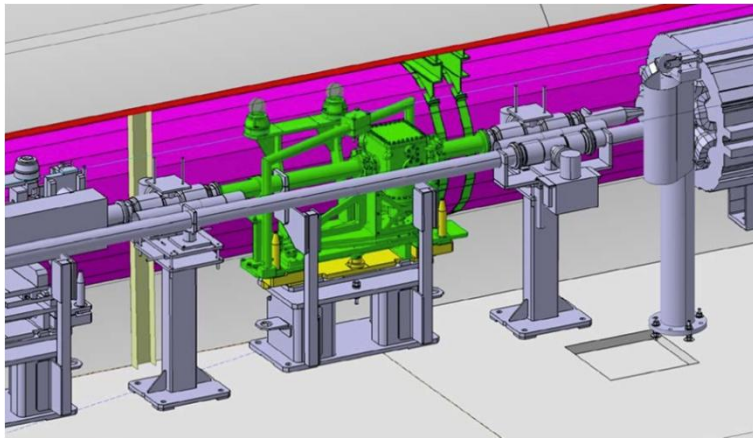

Expected crystal collimation cleaning ~x5 better than standard collimation

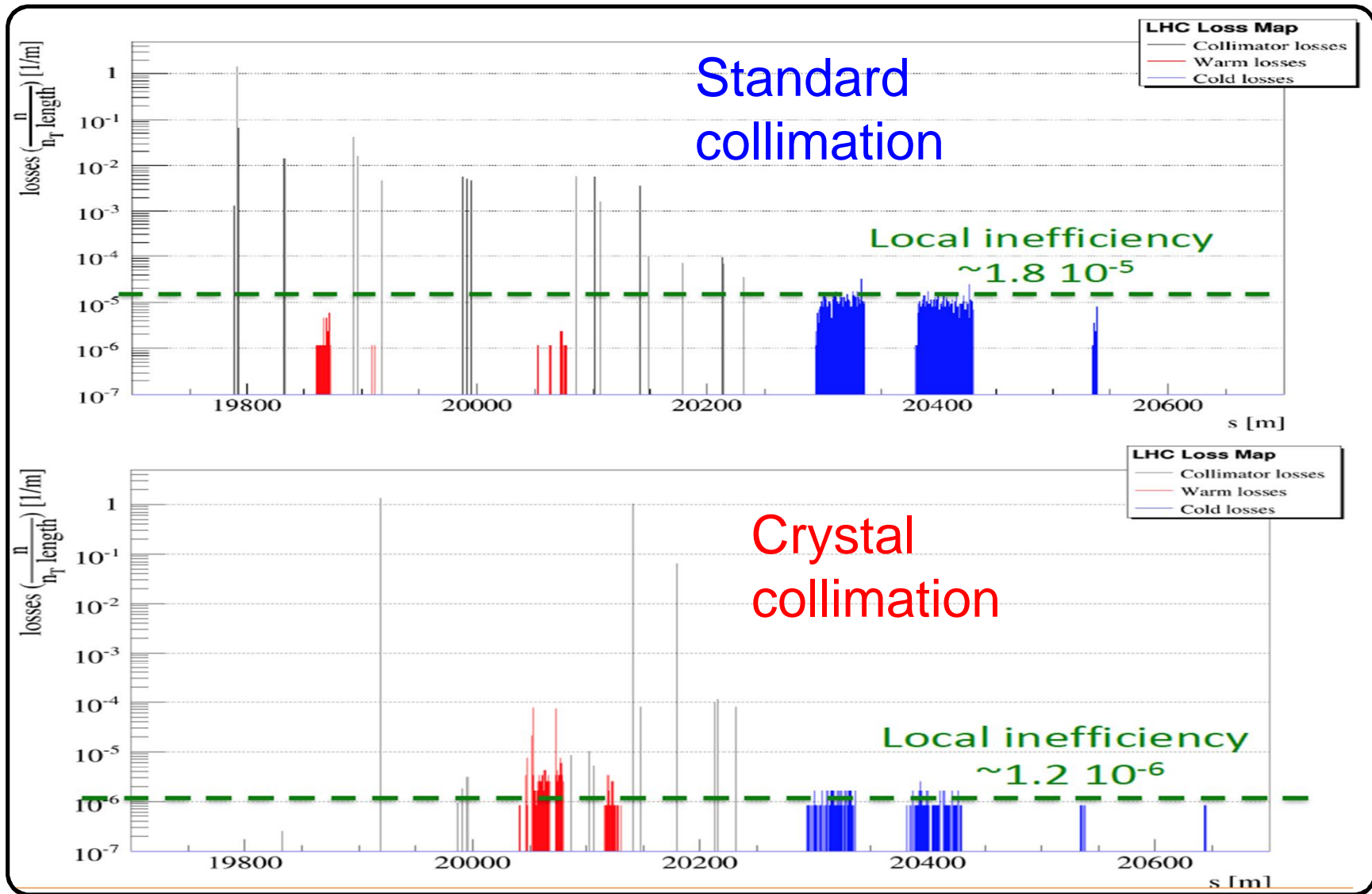

Summary of LHC Crystal Test layout

- ☑ Initial installation (April 2014):
 - Two goniometers on beam 1 only (horizontal + vertical)
 - Preparation of infrastructure for additional detectors
 - Improved beam instrumentation (fast diamond loss monitors)
- ☑ 4mm crystals with bending angle in each plane: **50 μ rad**
- ☑ Existing CFC secondary collimator & absorber intercept channeled beam
 - Different collimator configurations required to intercept the channeled beam*
- ☑ Crystal layout suitable for beam tests from injection energy (450 GeV) to maximum LHC energy (6.5 TeV in 2015)
- ☑ Possibility to improve cleaning relies on 5 other absorber collimators.
 - A Carbon-based collimator is used to intercept the beam: not enough absorption for cleaning!*

The End

Issues Driving Collimator Development

High Beam Power

- Parameters defining normal & allowable transient operation:
 - Cooling
 - Collimation Efficiency (density)
 - Activation & Rad-Hardness
- Collimation surface behavior under allowed transient beam load (injection aberration)
- Damage issues:
 - Optics to protect collimators from damage
 - Engineering to avoid or recover from damaging events

Small beam sizes and small gaps

- Impedance/Wakefields
 - Resistive, Geometric, Surface

Single Pass Operation vs. Rings

- Linear Colliders, Injection & Extraction lines

Brazing Each Moly Shaft End to a Central Copper Hub

After **much** R&D, developed method to braze Molybdenum to Copper for inner shaft

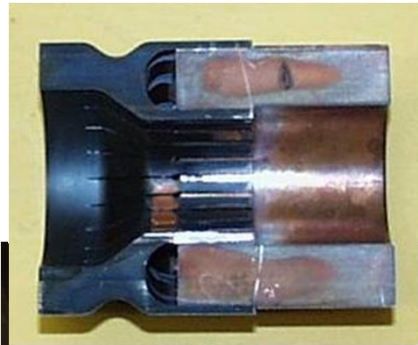

Shaft halves

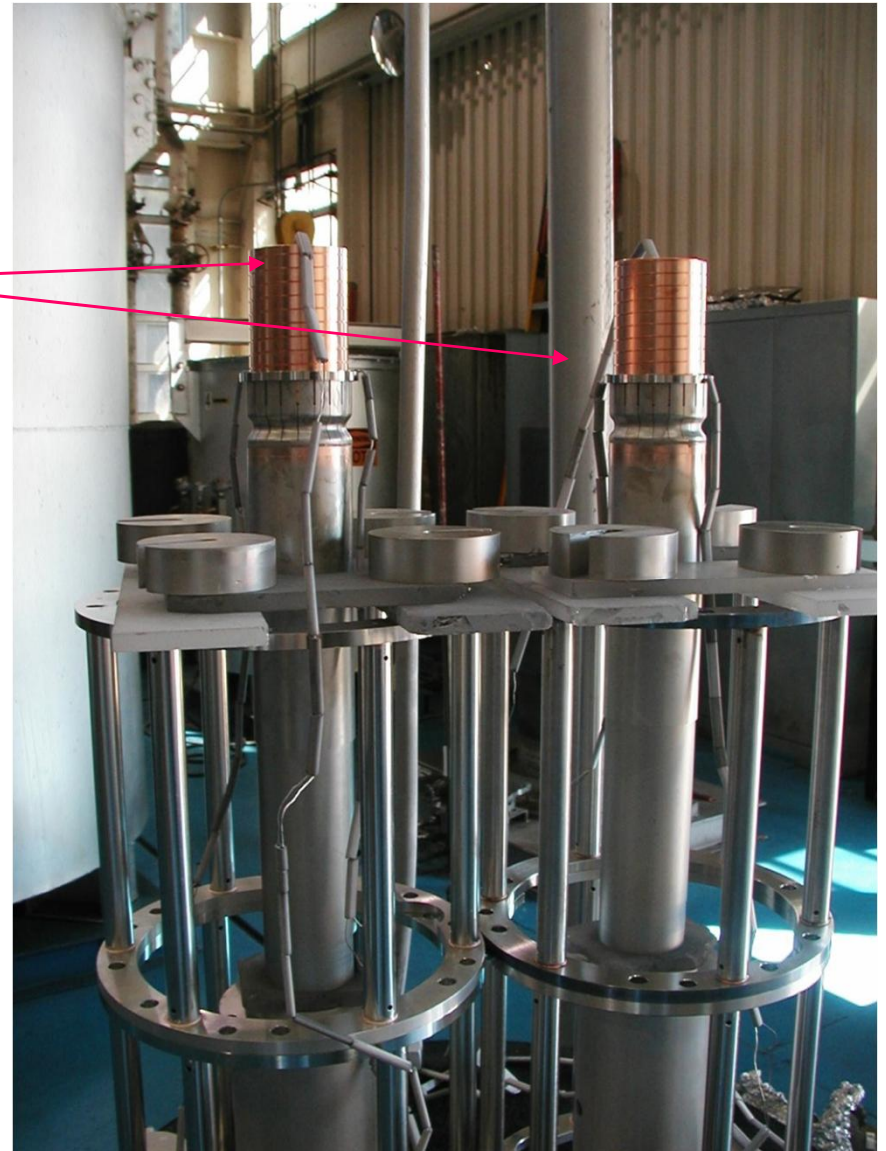
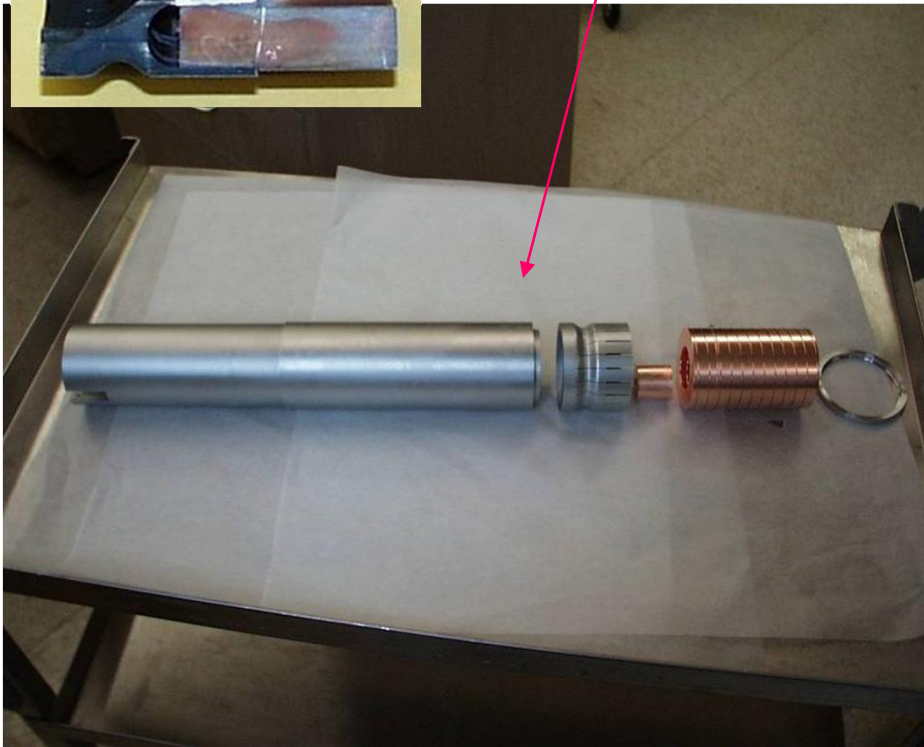

- 1) Wind 10mm x 10mm cooling coil into over-deep grooves
- 2) Protect coil with shims,
- 3) Braze
- 4) Machine to braze tolerance

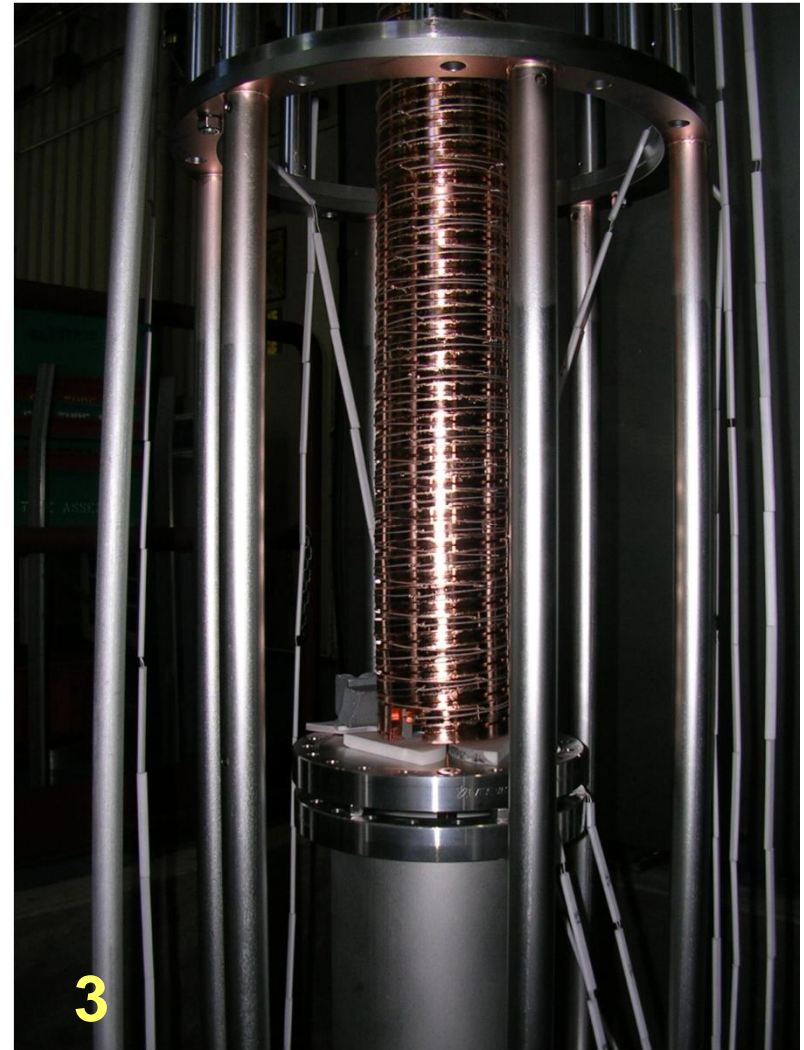
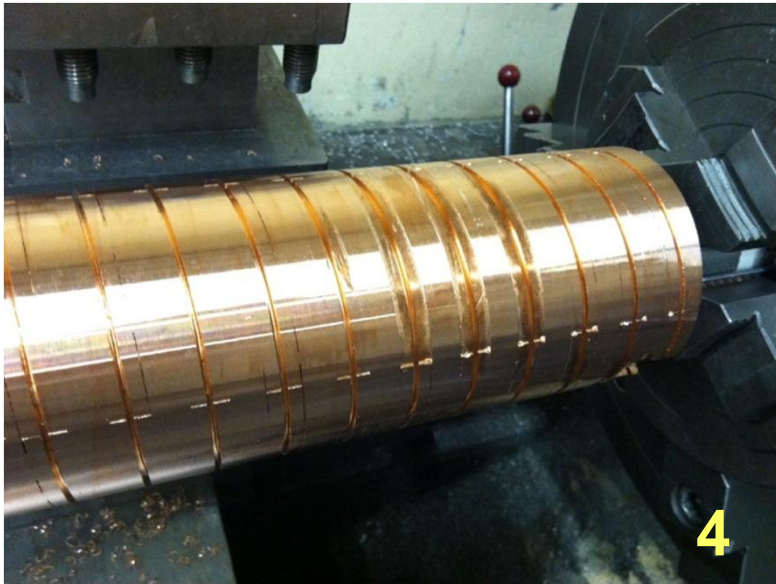
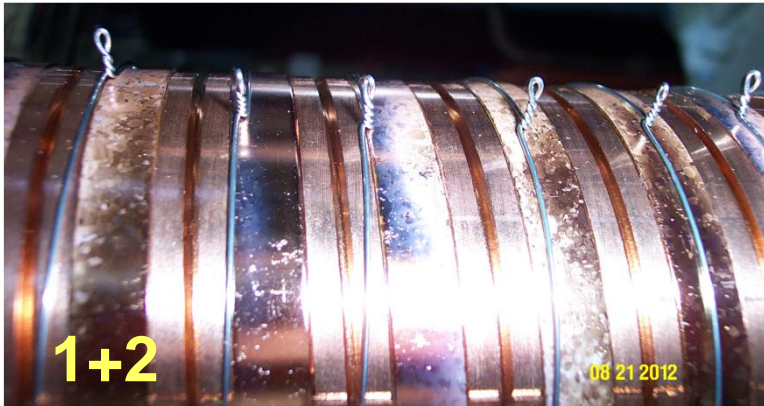

- 1) Machine Glidcop Cylinders**
- 2) Copper “flash”**
- 3) Load with braze wire & sheet**
- 4) Assemble over mandrel & braze**
- 5) Machine facets centered on rotation axis**

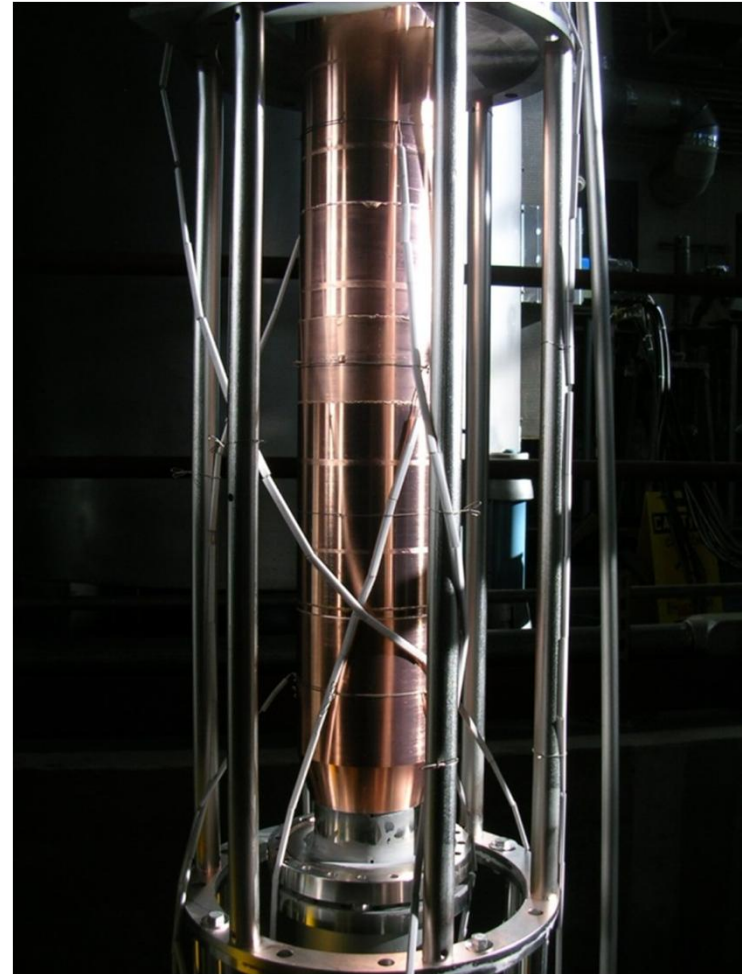
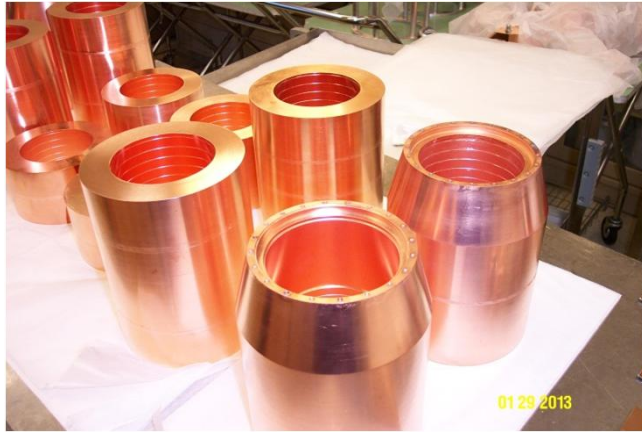

Hollow Electron Beam Gun in Tevatron

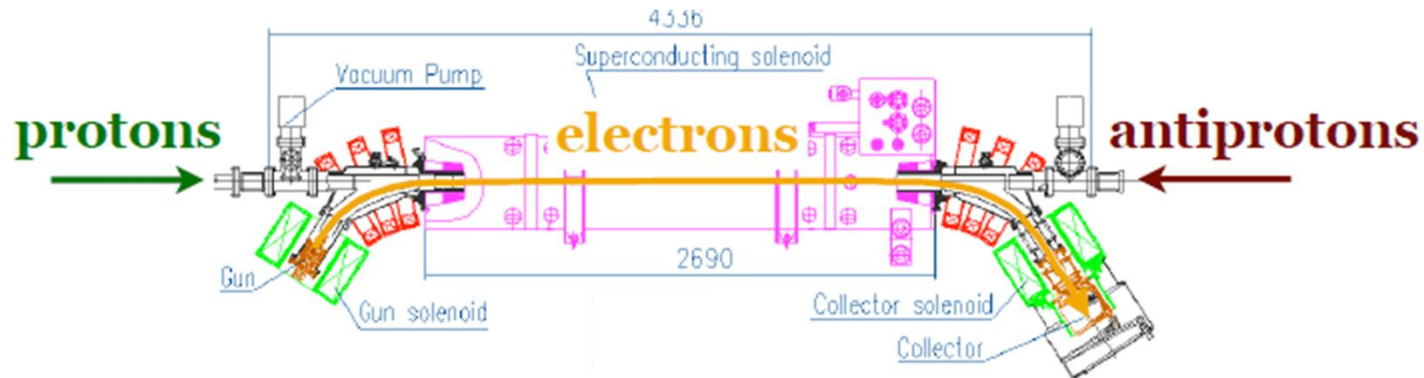

Transverse separation is 9 mm

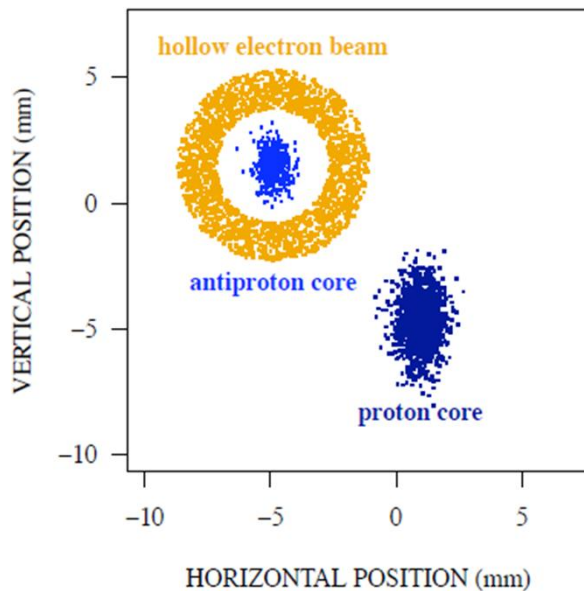

Pulsed electron beam
can be synchronized with
any group of bunches

18 experiments 2010.10-2011.06

- Tail of selected bunch depopulated
- Control bunches & core of selected bunch unaffected