

# Vacuum Science and Technology for Accelerator Vacuum Systems

*Yulin Li and Xianghong Liu  
Cornell University, Ithaca, NY*

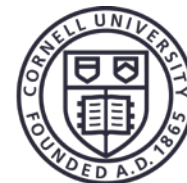

Cornell Laboratory  
for Accelerator-based Sciences  
and Education (CLASSE)

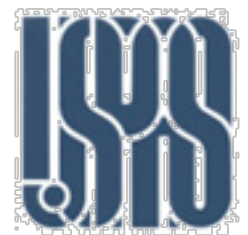

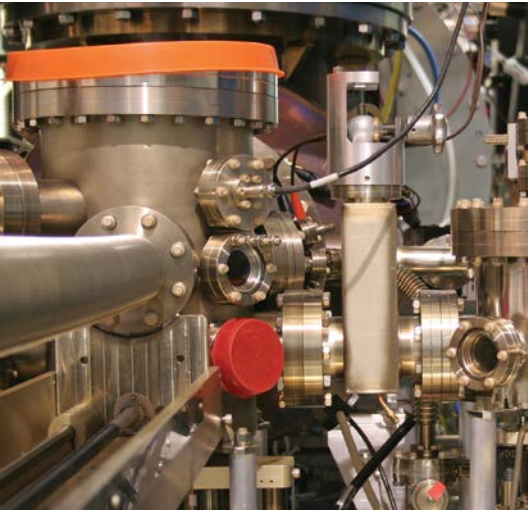

# Table of Contents

- Vacuum Fundamentals
- Sources of Gases
- Vacuum Instrumentation
- Vacuum Pumps
- **Vacuum Components/Hardware**
- Vacuum Systems Engineering
- Accelerator Vacuum Considerations, etc.

# SESSION 5.1: VACUUM MATERIALS

- Metals
  - Stainless Steels
  - Aluminum and Alloys
  - Copper and Alloys
  - Other metals
- Non-metals
  - Ceramics and Glasses
  - Polymers

# *Stainless Steels – Classifications*



- ❑ *Stainless steel is a steel alloy with at least 11% chromium content by weight. It is also called corrosion-resistant steel.*
- ❑ *Austenitic stainless steel (300 series): These are generally non-magnetic steel alloys. They contain a maximum of 0.15% carbon, a minimum of 16% chromium and sufficient nickel and/or manganese to retain an austenitic structure at all temperatures from the cryogenic region to the melting point of the alloy. The low carbon (-L) grades are used when welding is involved. In UHV applications, especially accelerators, 300 stainless steels are commonly used.*
- ❑ *Other less used types of stainless steel alloys are: Martensitic stainless steels (400 series), precipitation-hardening martensitic stainless steels (most common used 17-4PH) and ferritic stainless steels. Martensitic stainless steels are much more machinable, and are magnetic. Those are much less used for accelerators, mainly due to the magnetism.*

# Austenitic Stainless Steels



- ❖ *High strength, moderate formability, excellent weldability.*
- ❖ *Can be extruded in simple shapes*
- ❖ *304L SS, most commonly used in vacuum, but may become magnetized from machining and welding.*
- ❖ *316L SS, with Mo added, more expensive, resistant to chemical attack, welds are non-magnetic*  
*316LN SS, a nitrogen-enhanced 316L steel, much more expensive, but excellent strength at very elevated temperatures (as high as 1000°C)*
- ❖ *Wide variety of circular tubes and pipes available (seamless & welded)*
- ❖ *Outgassing rates can be decreased by employing good machining techniques, chemical cleaning and baking (up to 900°C)*
- ❖ *Poor thermal and electrical conductivity*

# Family of Austenitic Stainless Steels

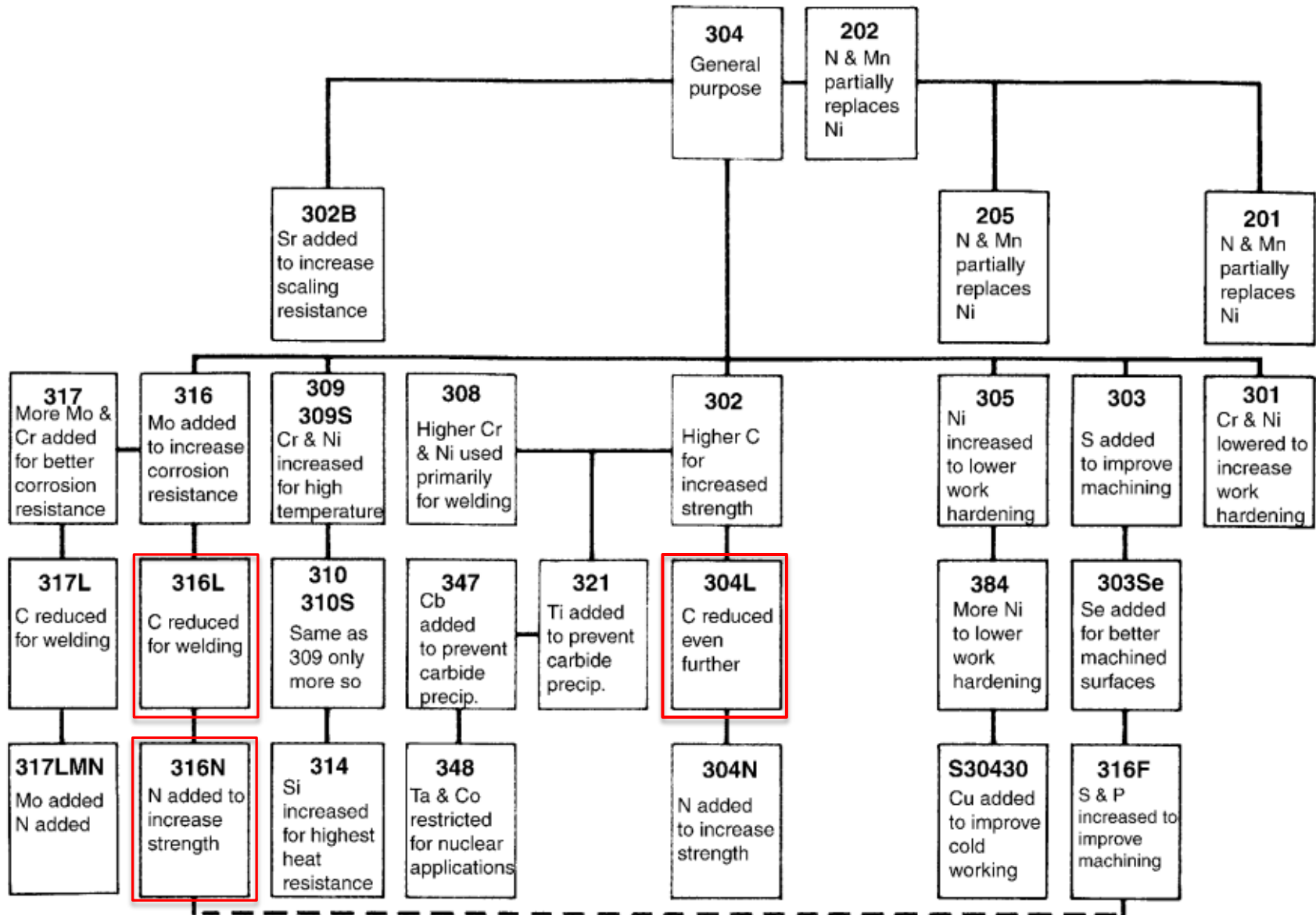

# Mechanical Properties for Stainless Steels



Property	304L	316L	316LN	OFE Cu
Ultimate Tensile Strength (MPa)	564	560	637	338
Tensile Strength (ksi)	81.8	81.2	92.4	49.0
Yield Strength (Mpa)	210	290	>280	217
Yield Strength (ksi)	30.5	42.1	>41.6	31.5
Elongation at Break (%)	58	50	58	55
Modulus of Elasticity (Mpa)	197	193	200	115
Modulus of Elasticity (ksi)	28.6	28.0	29.0	16.7

Ref. [www.matweb.com](http://www.matweb.com)



# Physical Properties for Stainless Steels



Property	304L	316L	316LN	OFE Cu
Composition:	C 0.03% Cr 18-20% Mn 2% <i>Fe Balance</i> Ni 8-12% P 0.045% S 0.03% Si 1%	C <0.03% Cr 17.9% Mn 2.0% Mo 2.5% <i>Fe Balance</i> Ni 11-14% S 0.03% Si 1%	C <0.03% Cr 17.9% Mn 2.0% Mo 2.5% <i>Fe Balance</i> Ni 10.8% N 0.16% S 0.03% Si 1%	Cu 100%
Melting Point (°C)	1427	1385	1400	1083
Density (g/cc)	8.0	8.0	8.0	8.92
Electrical Resistivity ( $\Omega$ -cm)	$7.2 \times 10^{-5}$	$7.2 \times 10^{-5}$	$7.4 \times 10^{-5}$	$1.71 \times 10^{-6}$
Elect. Conduct. (% IACS*)				101
Therm. Conduct. (W/m-K)	16.2	16.3	16.0	391
Coeff. Of Therm. Exp. ( $^{\circ}\text{C}^{-1}$ )	$17.2 \times 10^{-6}$	$16.0 \times 10^{-6}$	$16.0 \times 10^{-6}$	$17.5 \times 10^{-6}$





# Tubing - Seamless and Welded

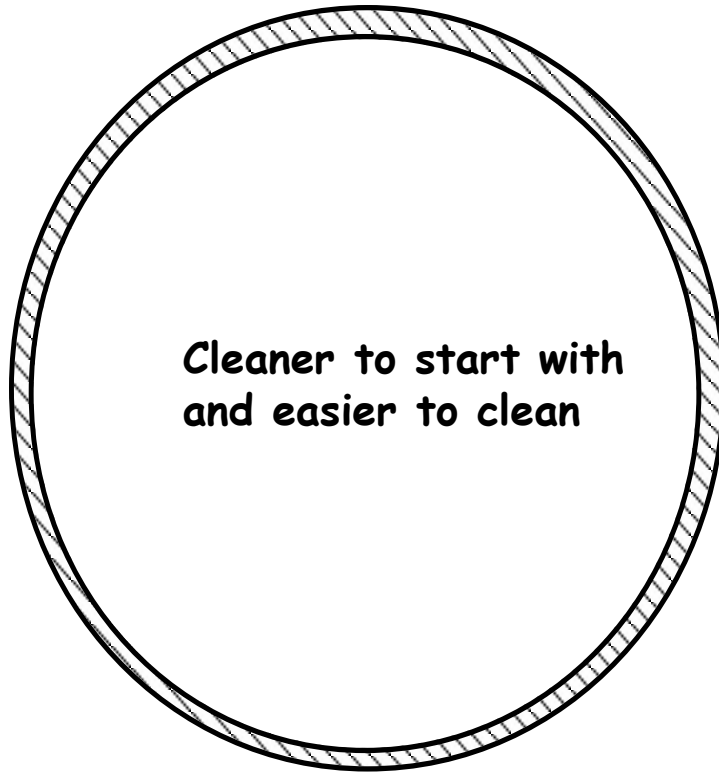

**Seamless (extruded)**

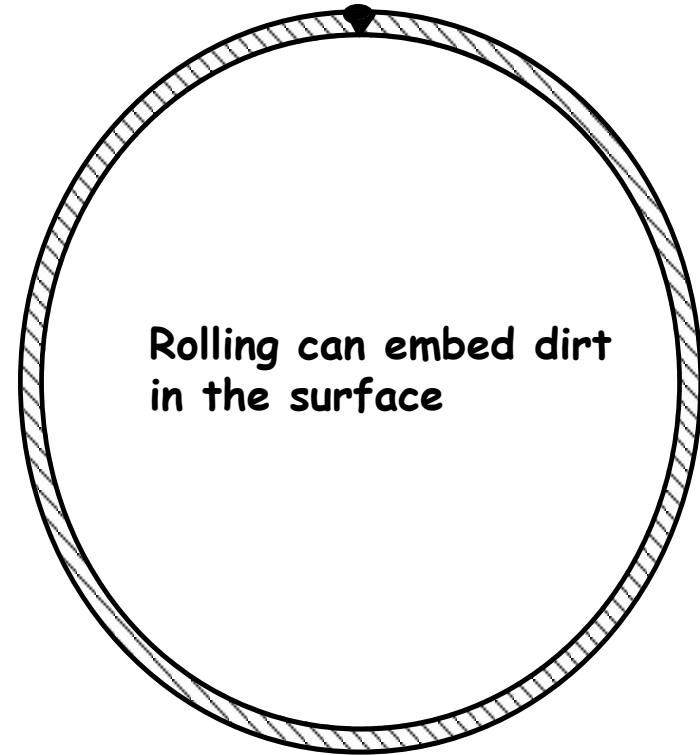

**Welded (rolled & welded)**



# Plate/Rod - ESR or Cross-Forged



- *Stainless steels are the most common material for making knife-edge sealing flanges*
- *For making knife-edge seal flanges, either ESR or cross-forged stainless steels should be used to avoid costly defects on the knife-edge tip*

**THE ELECTROSLAG REMELTING (ESR) PROCESS IS USED TO REMELT AND REFINE STEELS AND VARIOUS SUPER-ALLOYS, RESULTING IN HIGH-QUALITY INGOTS.**

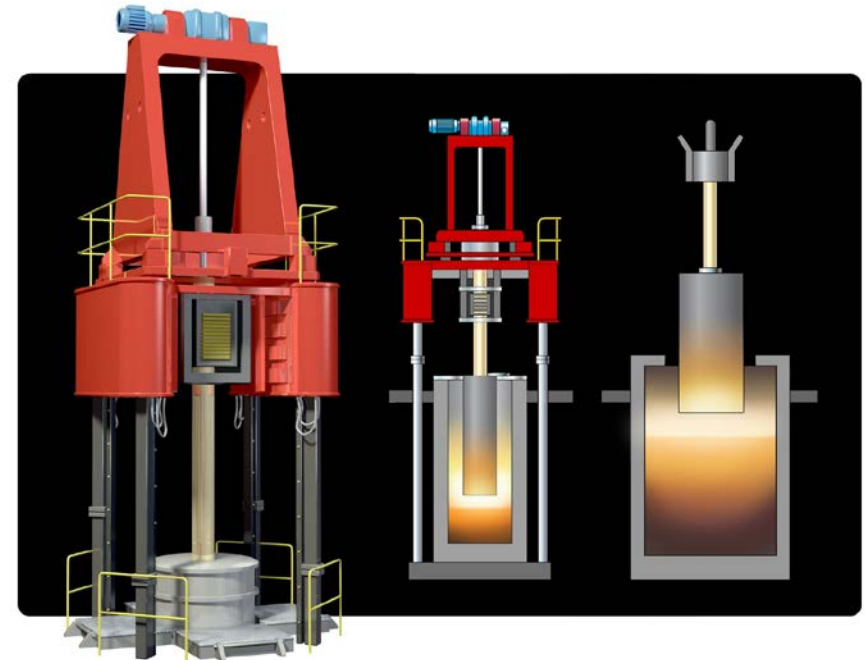

# Cornell DC Photo-Cathode Electron Gun Chamber

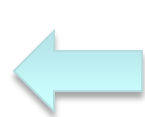

As received stainless steel gun chamber

Air-baked, and assembled to the gun, w/ pumps and gauges

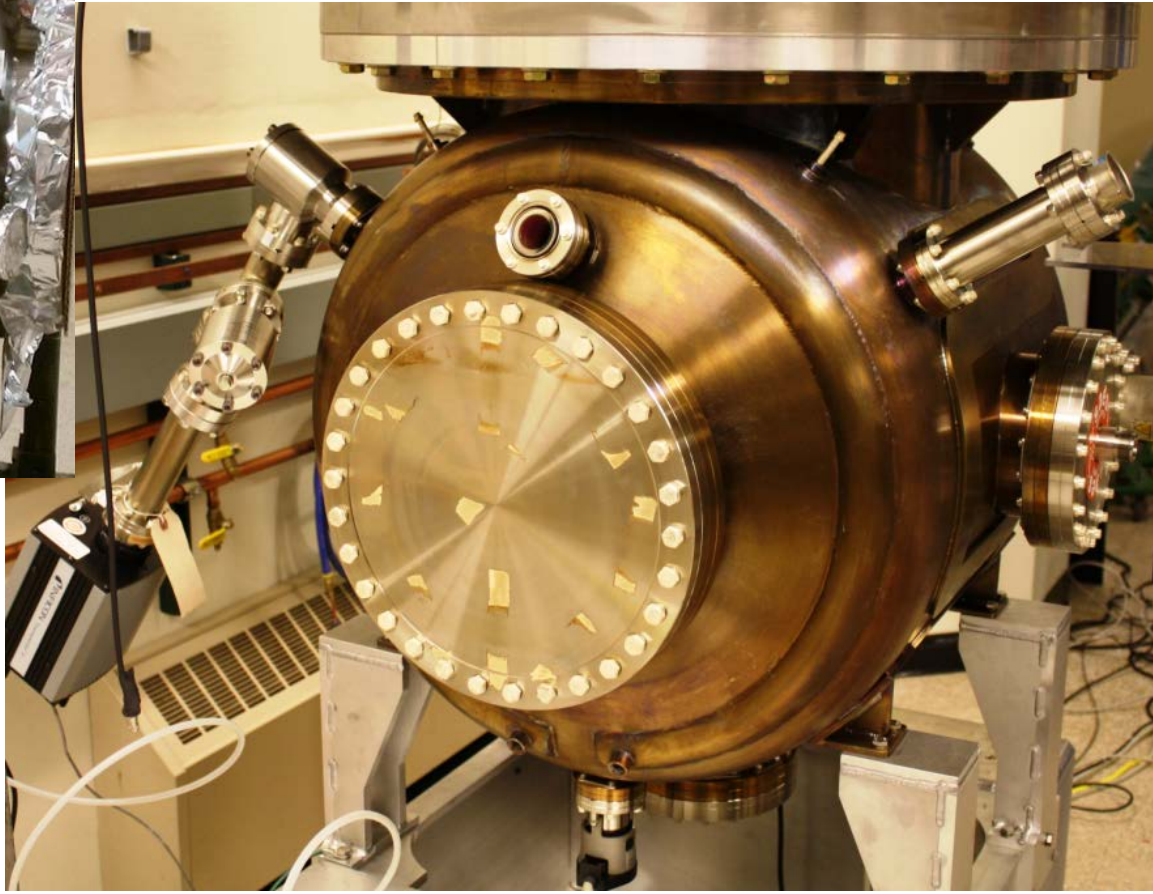

# Aluminum and Alloys



Alloy Number	Major Alloy Element(s)	Characteristics and Sample Applications
1xxx	None	Good electric and thermal conductivities, corrosion resistance. Typical applications: electric conductor wires and bus
2xxx	Copper	High strength, at room and elevated temperatures, Alloys 2011, 2017, and 2117 are widely used for fasteners and screw-machine stock
3xxx	Manganese	Similar property as 1100, slightly higher strength. Good for sheet works.
4xxx	Silicon	Excellent flow characteristics. Alloy 4032 for forging, 4043 used for GMAW and TIG 6xxx alloys.
5xxx	Magnesium	Mostly for structural applications, matching 6xxx extrusions well. 5083 alloy suitable for cryogenic applications.
6xxx	Magnesium + Silicon	6061-T6 is one of the most commonly used, 6063 is mostly used in extruded shapes
7xxx	Zinc	Mostly for structural, supporting frames. 7075-T6 is one of the most used 7000 series aluminum, and strongest one.
8xxx	Sn, Li, etc.	Specialty alloys not cover by other series.

# Aluminum and Alloys – Tempers



- *Besides alloy designations (with Nxxx), there are standard temper designations for aluminum alloys, with one letter and a numeral.*
- *For strain-hardened (cold-worked), there are hardness designations.*
  - F** as fabricated;
  - H1** Strain hardened without thermal treatment
  - H2** Strain hardened and partially annealed
  - H3** Strain hardened and stabilized by low temperature heating
- *For alloys can be heat treated to produce stable tempers (partial list)*
  - O** Full soft (annealed);
  - T2** Cooled from hot working, cold-worked, and naturally aged
  - T4** Solution heat treated and naturally aged
  - T5** Cooled from hot working and artificially aged (at elevated temperature)
    - T51** Stress relieved by stretching
      - T511** Minor straightening after stretching
  - T6** Solution heat treated and artificially aged
    - T651** Stress relieved by stretching



- ❖ *Moderate strength, good formability, easy to machine*
- ❖ *6063-T4 can be extruded in complicated shapes*
- ❖ *6061-T6 is the most common aluminum alloy for vacuum components*
- ❖ *5083 is a good alloy for welding*
- ❖ *Aluminum is much cheaper to machine than stainless steel (2x to 3x cheaper)*
- ❖ *Aluminum is much less likely been radiactivated.*
- ❖ *Special care must be taken in the design of welds and the techniques used due to higher thermal conductivity and thermal expansion (30% > SS)*
- ❖ *Surface anodizing degrades outgassing characteristics, but improves chemical resistance*

# Typical Mechanical Properties for Aluminum



Property	1100-0	5083-H34	6061-T6	OFE Cu
Tensile Strength (MPa)	165	345	310	338
Tensile Strength (ksi)	23.9	50.0	45.0	49.0
Yield Strength (Mpa)	150	280	275	217
Yield Strength (ksi)	21.8	40.6	39.9	31.5
Elongation (%)	5	9	12	55
Modulus of Elasticity (Mpa)	69	70.3	69	115
Modulus of Elasticity (ksi)	10.0	10.2	10.0	16.7

Ref. [www.matls.com](http://www.matls.com)



# Typical Physical Properties for Aluminum



Property	1100-0	5083-H34	6061-T6	OFE Cu
Composition:	Al 99% Cu 0.05-0.2% Mn 0.05% Si+Fe 0.95% Zn 0.1%	Al 94.8% Cu 0.1% Cr 0.05-0.25% Mg 4-4.9% Mn 0.4-1% Fe 0.4% Si 0.4% Ti 0.15% Zn 0.25%	Al 98% Cu 0.15-0.4% Cr 0.04-0.35% Mg 0.8-1.2% Mn 0.15% Fe 0.7% Si 0.4-0.8% Ti 0.15% Zn 0.25%	Cu 100%
Melting Point (°C)	643	591	582	1083
Density (g/cc)	2.71	2.66	2.7	8.92
Electrical Resistivity ( $\Omega$ -cm)	$3 \times 10^{-6}$	$5.9 \times 10^{-6}$	$3 \times 10^{-6}$	$1.7 \times 10^{-6}$
Heat Capacity (J/g-°C)	0.904	0.9	0.896	0.385
Therm. Conduct. (W/m-K)	218	117	167	391
Coeff. Of Therm. Exp. (°C <sup>-1</sup> )	$25.5 \times 10^{-6}$	$26 \times 10^{-6}$	$25.2 \times 10^{-6}$	$17.5 \times 10^{-6}$

Ref. [www.matls.com](http://www.matls.com)





# More on 6061-T6 Alloy – Heating Effects

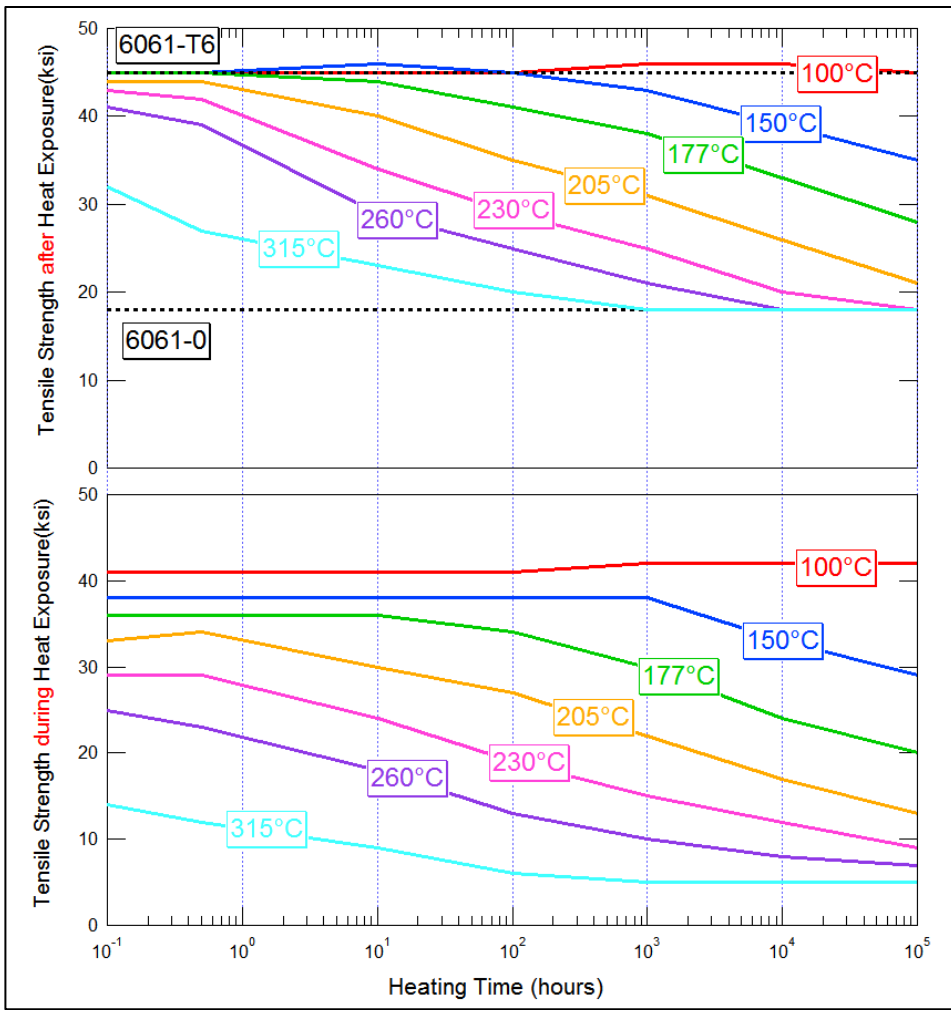
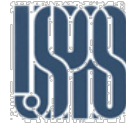

- ❑ 6061-T6 alloy loss strength quickly at temperature above 177°C, the typical artificial aging temperature during heat-treatment.
- ❑ Heating above 150°C can anneal 6061-T6 alloy over time. So bakeout temperature should be at or below 150°C if -T6 strength is to be retained.

Ref. Properties of Aluminum Alloys, Tensile, Creep and Fatigue Data at High and Low Temperatures, by J. Kaufman, p. 168



# Machined Aluminum "Switch-yard" Chamber

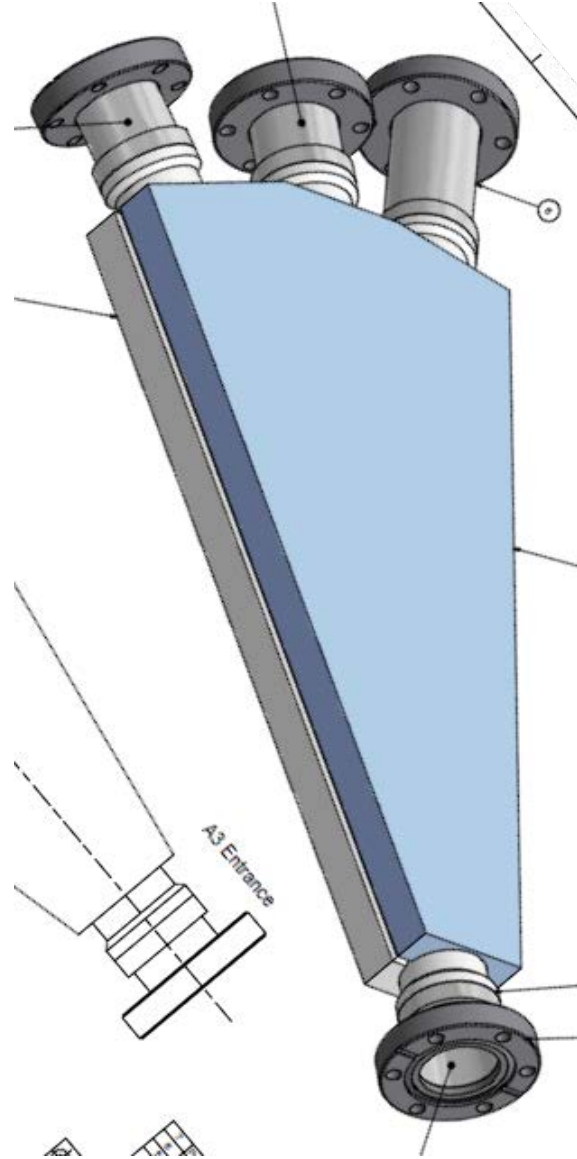
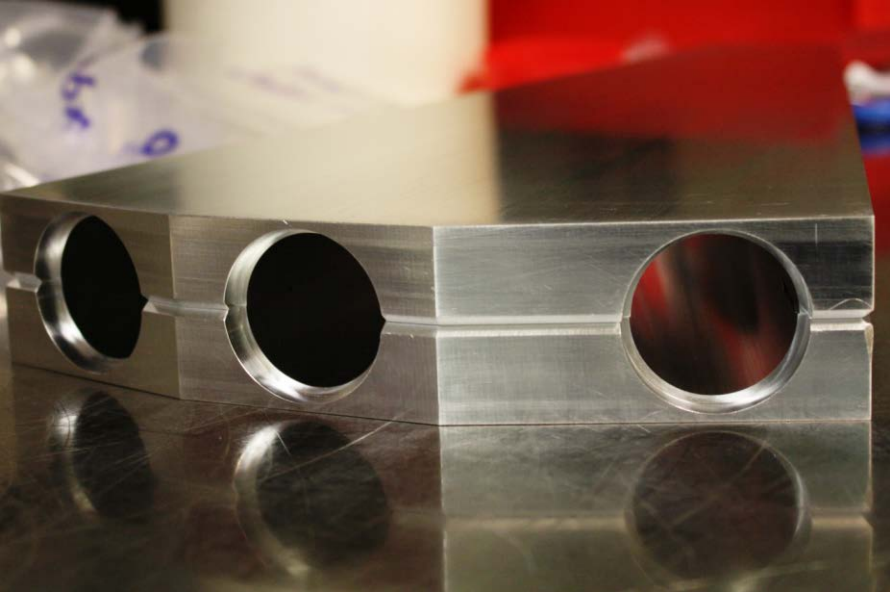

# Aluminum Electron Beam Stopper



*600 kW/15 MeV Beam Stopper for Cornell Prototype ERL Injector*

# Extruded Beam Pipes – Complex Shape

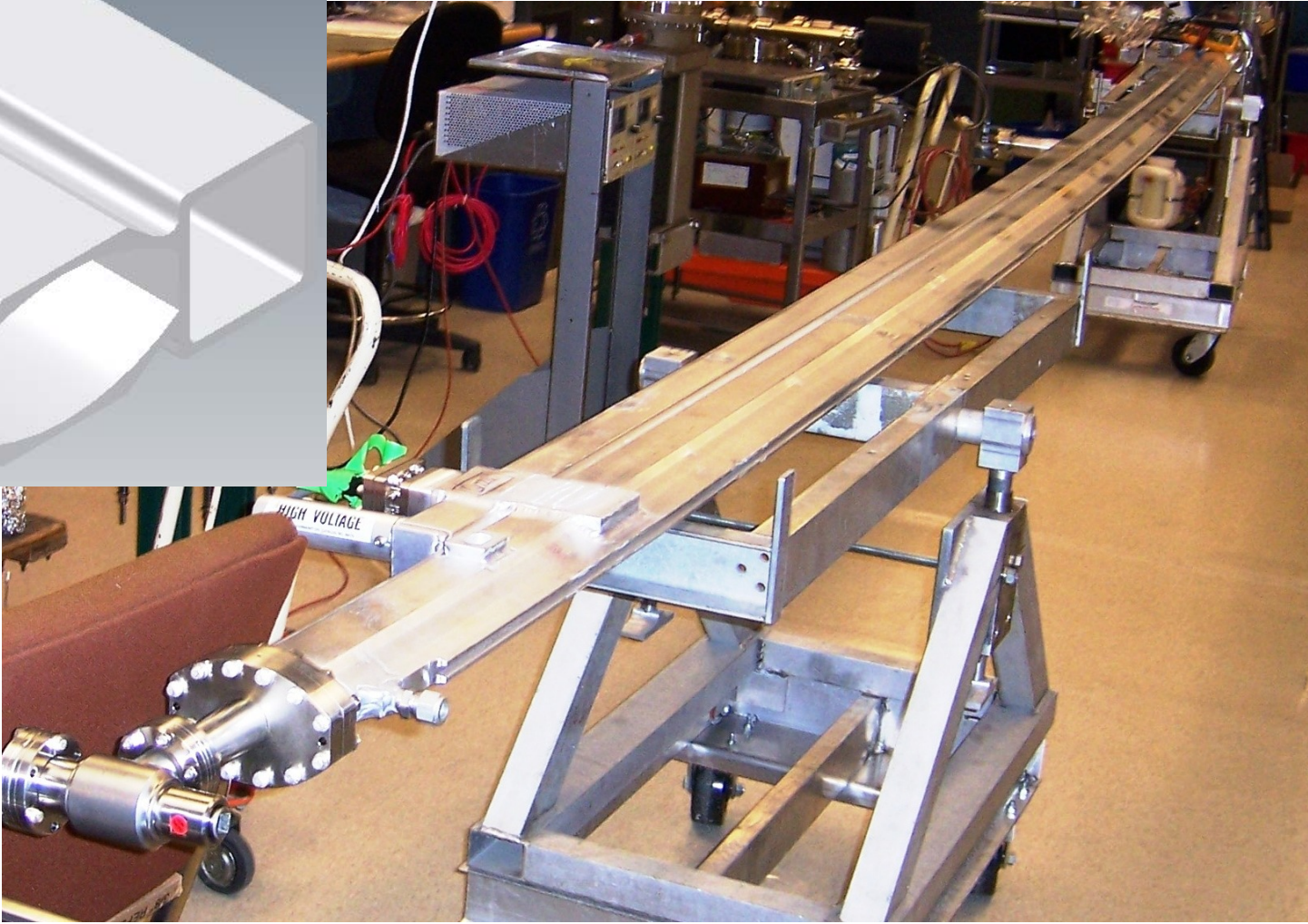
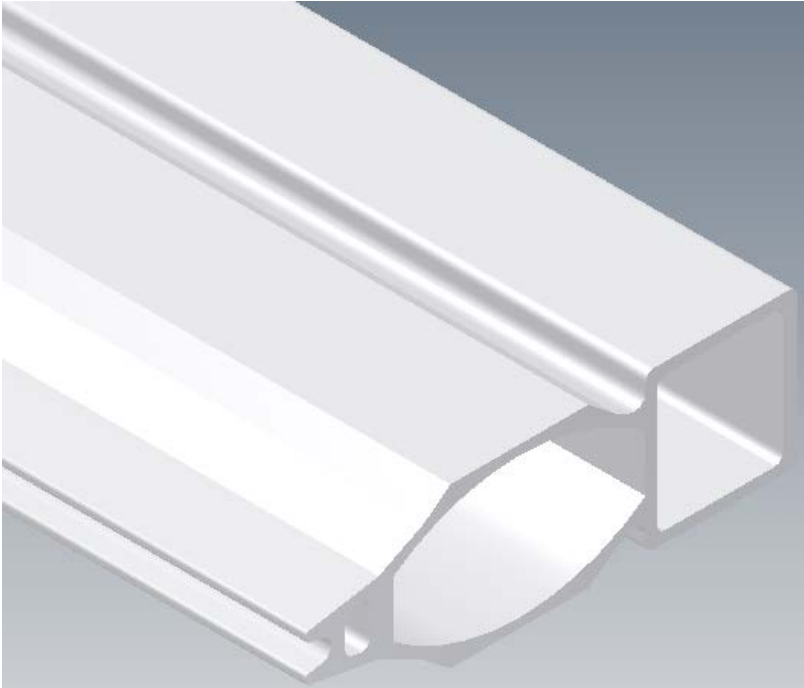
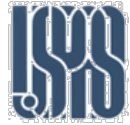

# Extruded Beam Pipes – Undulator Chamber

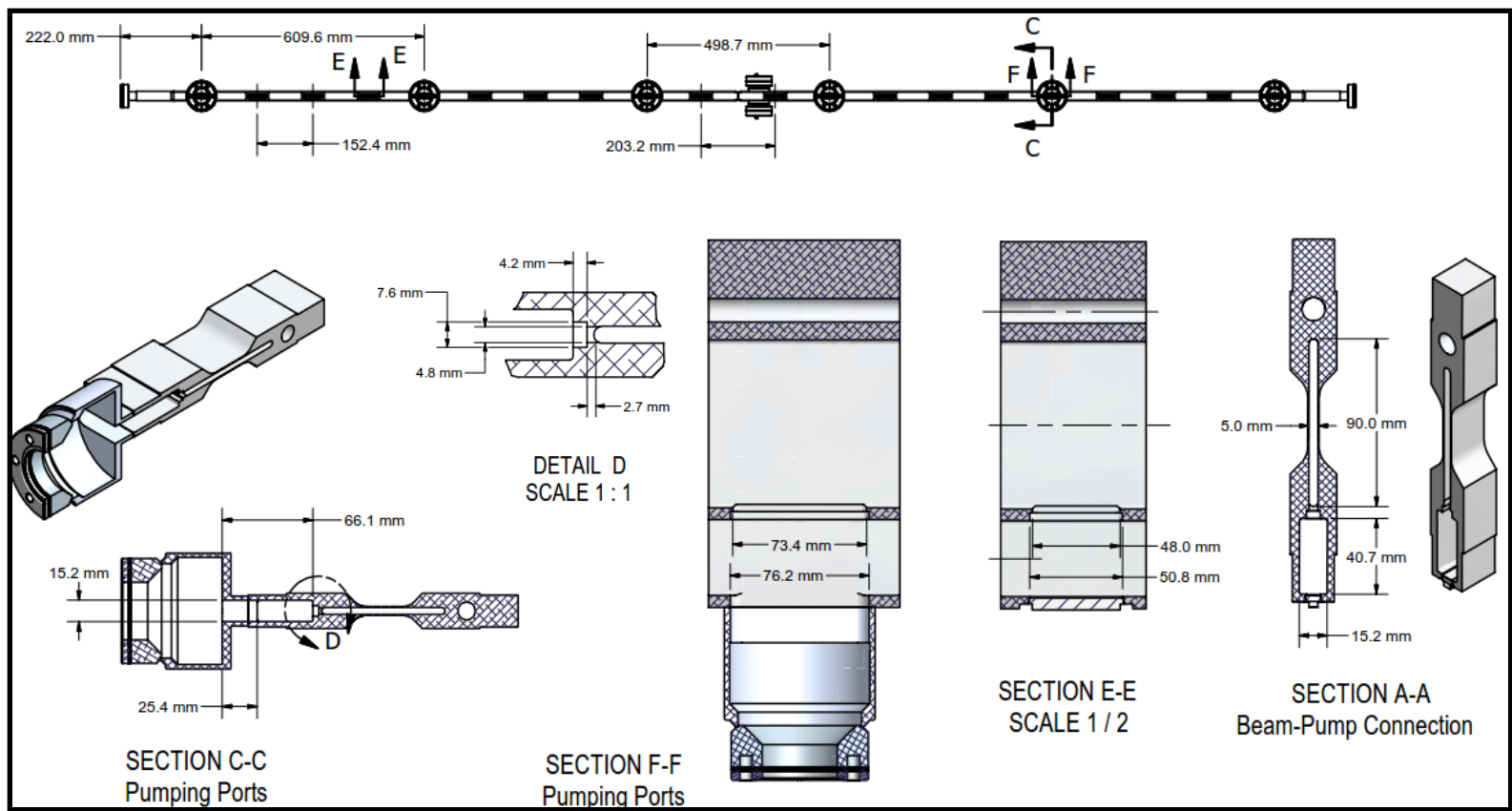
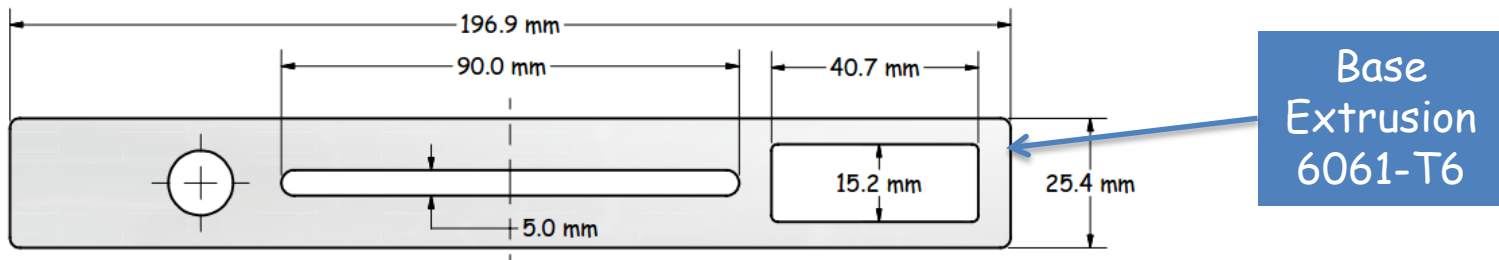

# Extruded Beam Pipes – Undulator Chamber

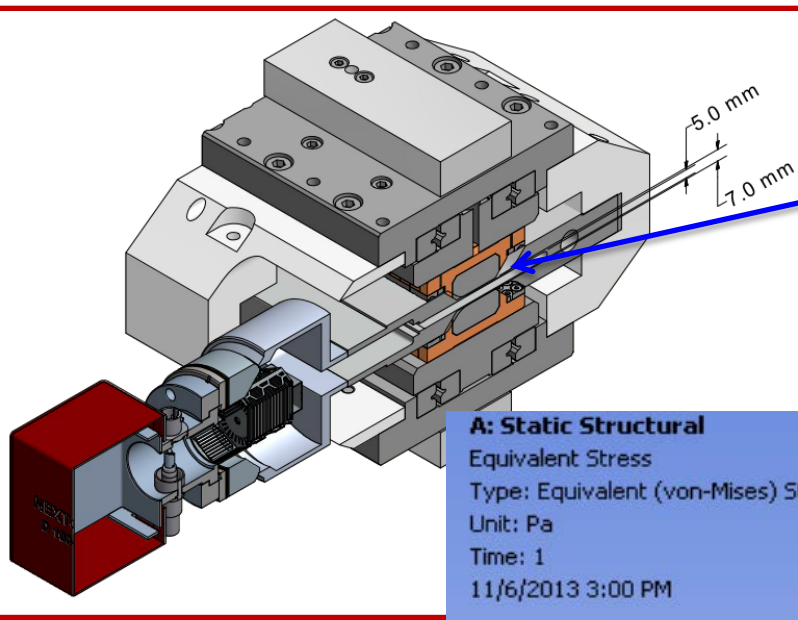

Extrusion machined to 0.6-mm thin to allow small undulator gap

FEA and tests to ensure adequate safety factor (>2 in this case)

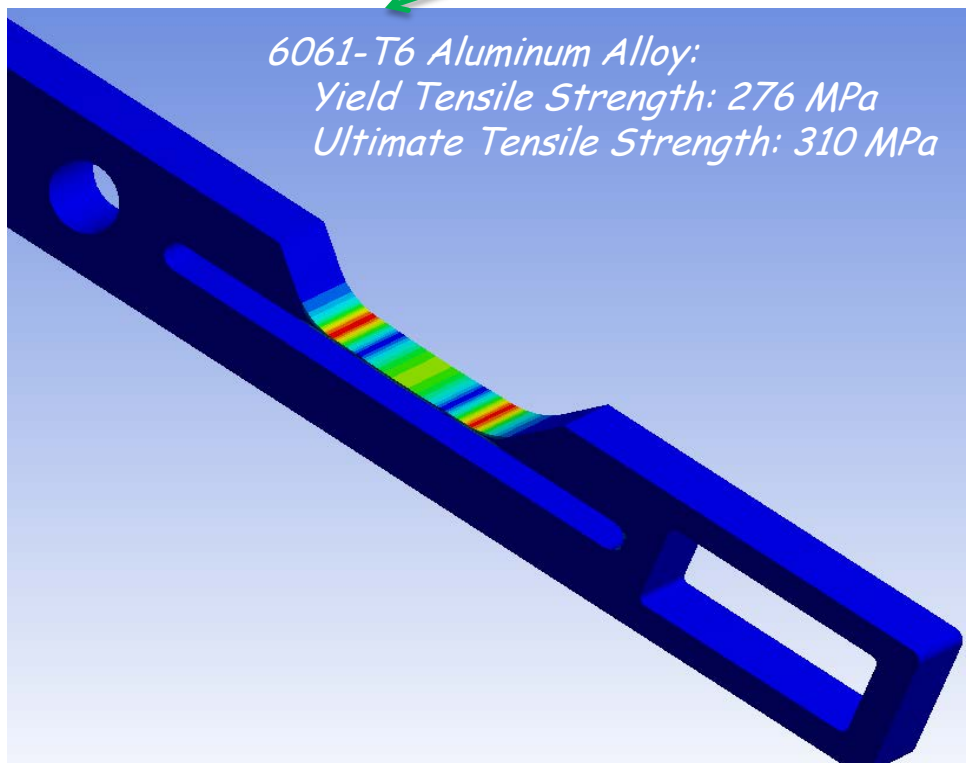

# Copper and Alloys



- *Copper and alloys are designated by a system starting with letter "C", followed by 5 digits, more copper contents with lower numbers.*
- *Some commonly used copper alloys are C10100 (OFHC), C26800 (Yellow Brass, Zinc alloy), C61400 (Bronze, Silicon alloy), C17200 (Beryllium coppers)*
- *Low-to-moderate strength, good formability*
- *Excellent electrical and thermal characteristics*
- *Difficult to weld (e-beam welding is best)*
- *May be joined by welding, brazing, and soldering*
- *Good outgassing characteristics, rates can be decreased by following good machining techniques, chemical and baking (~200° C)*



# Oxygen-Free High Conductivity (OFHC) Copper



- ❑ *Oxygen-free high thermal conductivity (OFHC) copper generally refers to a group of wrought high conductivity copper alloys that have been electrolytically refined to reduce the level of oxygen to 0.001% or below.*
- ❑ *OFHC is often used in accelerator vacuum system, where high heat load is encountered. It is also used to construct normal conducting radio-frequency (RF) cavities.*
- ❑ *C10100 - This is the purest grade, with 99.99% Cu, <0.0005% (or 5 ppm) oxygen content.*
- ❑ *C10200 - 99.95% Cu (including Ag), <0.001% (10-ppm) oxygen content.*
- ❑ *C11000 - Also known as Electrolytic-Tough-Pitch (ETP) copper. It is 99.9% pure and has 0.02% to 0.04% oxygen content (typical).*
- ❑ *Low oxygen content is critical for vacuum assemblies involving welding*





# OFHC Copper Properties



Density	Electric Resistivity	Thermal Conductivity	C.T.E.	M.P.
8.9 g/cc	$1.71 \times 10^{-6} \Omega\text{-cm}$	383 ~ 391 W/m-K	17.0 $\mu\text{m/m-K}$	1083°C

Temper Designation Standard	Tensile Strength (ksi)		Yield Strength
	Min.	Max.	(ksi, min.)
060 Soft	30	38	--
H00 Cold-Rolled, 1/8-hard	32	40	20
H01 Cold-rolled, 1/4-hard	34	42	28
H02 Half Hard	37	46	30
H03 3/4-hard	41	50	32
H04 Full hard	43	52	35

- The hard-tempers of pure coppers can only be achieved via work-hardening, i.e. cannot be hardened by heat-treatment.*
- Annealing of pure copper starts as low as 150°C*

# Copper Vacuum Chamber Example



*C10100  $\frac{1}{2}$ -Hard Cu sheet bend to U-box to form a TiSP pumping plenum*

*C10100  $\frac{1}{2}$ -Hard Cu plates machined to form a beam pipe*

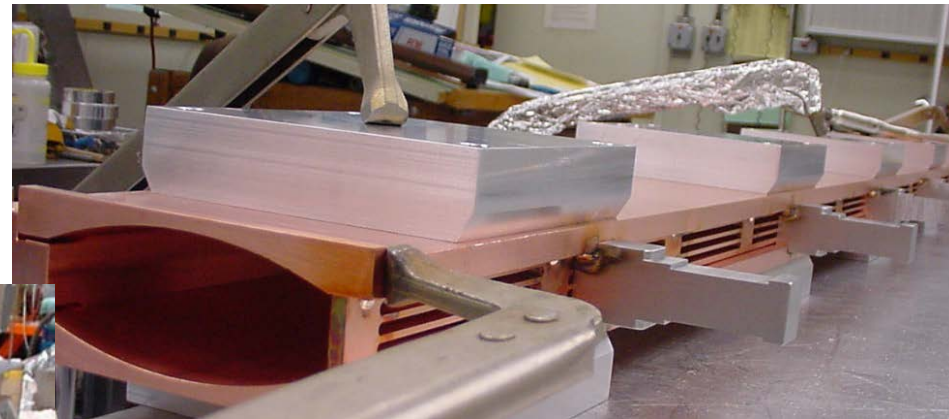

*SST L-shaped plates added to complete vacuum envelop, with enhance mechanical strength.*

*(Flanges to be added)*



# Copper Extrusions

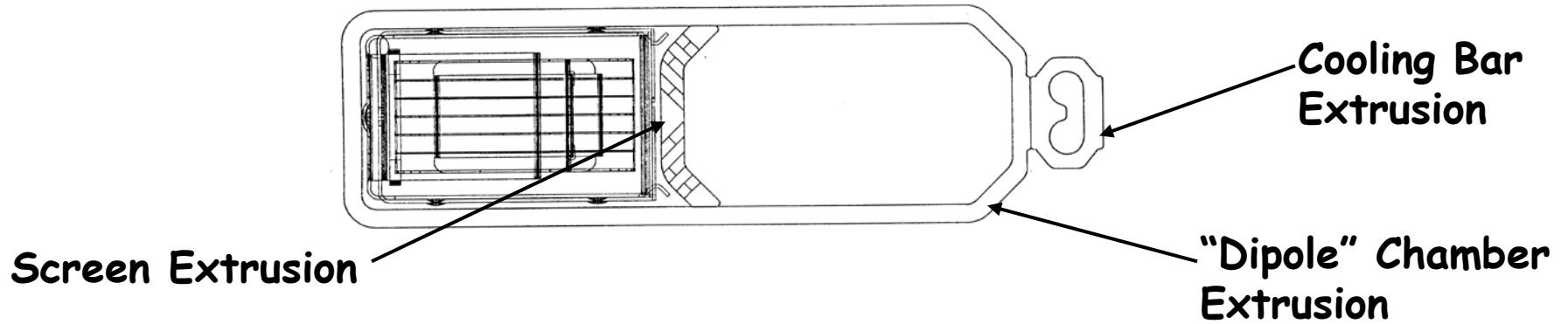

# Machined Copper Chamber (PEP-II RF Cavities)

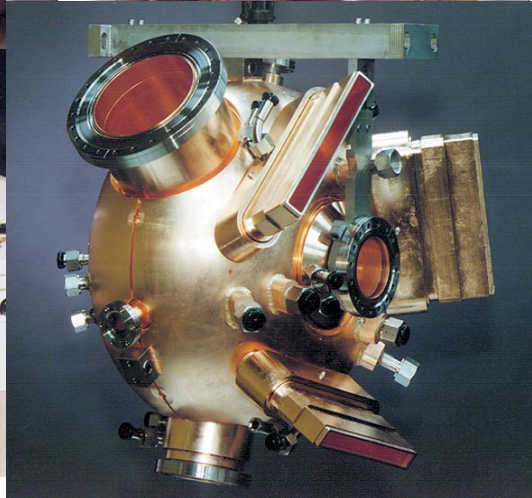
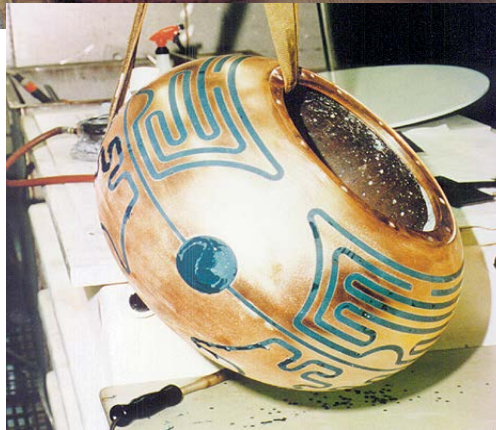

- 26 cavities
- \$4M total fabrication cost
- Integral cooling channels with electroformed cover
- 5 axis machining
- e-beam welded
- 17 separate manufacturing steps



*W-Target*

*Focusing Coil*

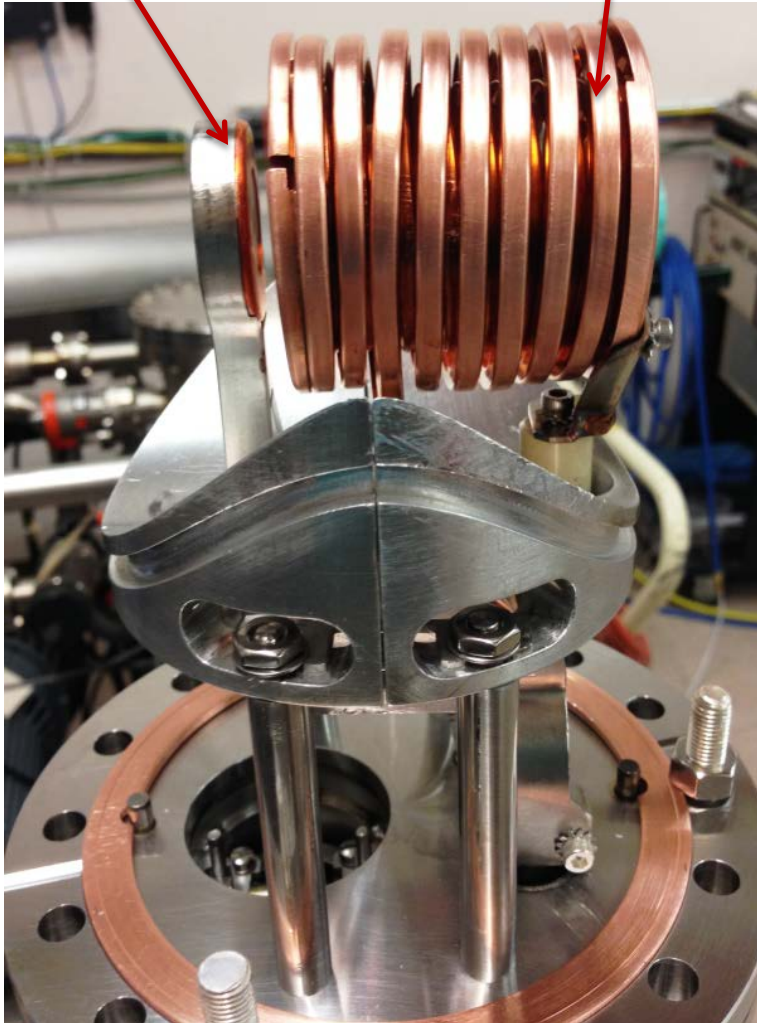

- ❑ *Pulsed current flowing through a two-layer coil to focus positrons from the target to down-stream accelerator.*
- ❑ *Tubular copper conductor in full annealed temper for winding.*
- ❑ *The formed coil (with vacuum brazed end caps) must be hardened to withhold turn-to-turn pulsing forces.*
- ❑ *The hardening was achieved by manual stretch-compression cycles.*

# Copper Strengthening



- ❑ *OFHC coppers are commonly used for construction of accelerator vacuum chambers for their excellent thermal and electric conductivity. Comparing to aluminum alloys, OFHC coppers also provide better radiation (especially gamma) shielding.*
- ❑ *However, pure copper has relatively low strength, even hardened. For applications with higher stresses (especially cyclic loading), the strength of copper can be improved by various strengthening mechanisms.*
- ❑ *Precipitation hardening (PH) coppers are heat-treatable to very much higher strength, while retaining its high electric and thermal conductivities. A commonly used PH copper is CuCrZr (UNS C18150).*
- ❑ *Dispersion-strengthened (DS) coppers are among the other commercially available materials, GlidCop<sup>®</sup>, Al15, Al25 and Al60.*

---

**A good reference:** M. Li and S. J. Zinkle, "Physical and Mechanical Properties of Copper and Copper Alloys", *Comprehensive Nuclear Materials* (2012), Vol. 4, pp. 667-690)

# Mechanical Strength vs. Thermal Conductivities

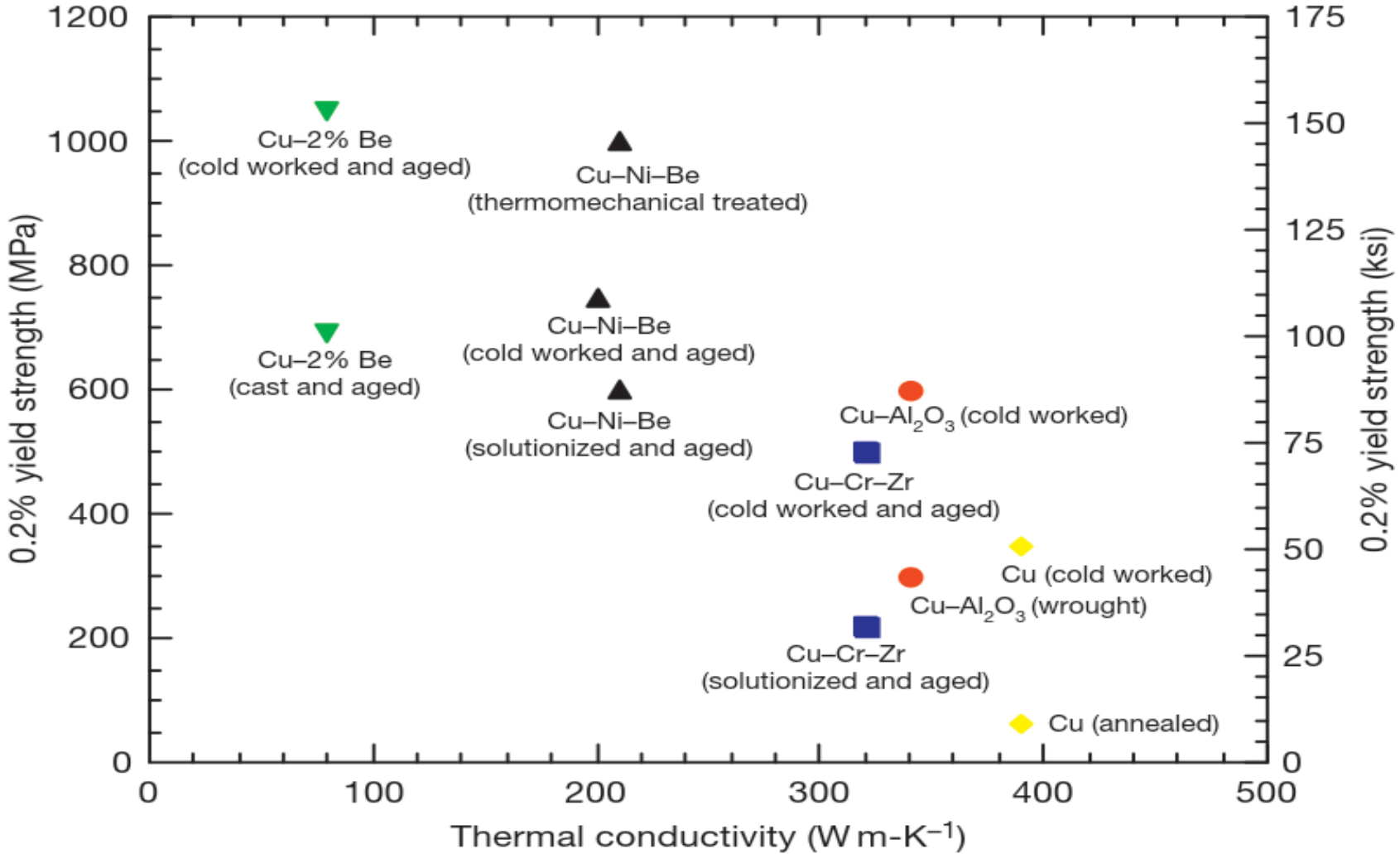

G. Li, et al, Metall. Mater. Trans. A 2000, 31A, 2491



# Mechanical Strength at High Temperatures

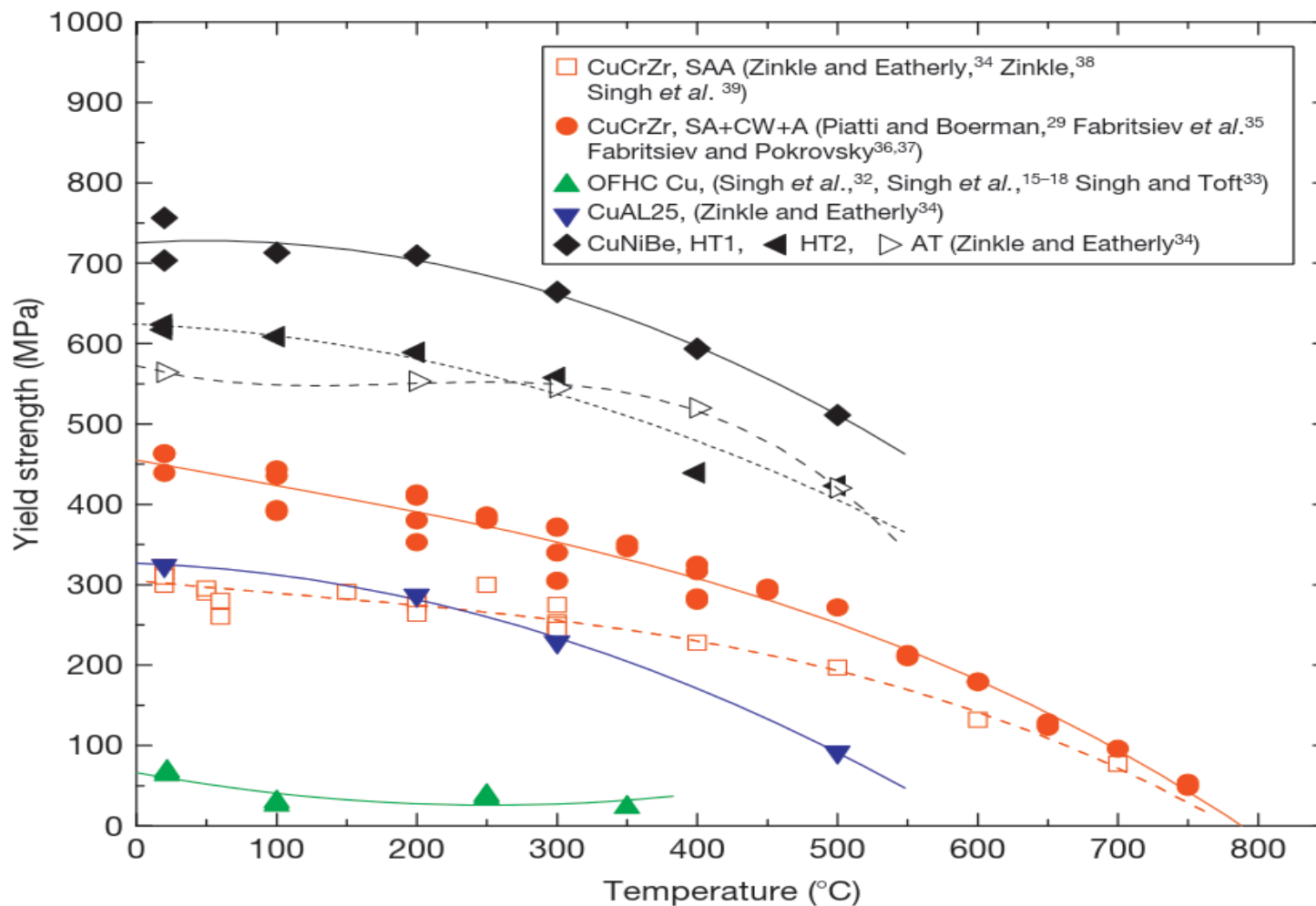
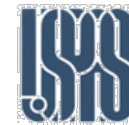

Reference: M. Li and S. J. Zinkle, "Physical and Mechanical Properties of Copper and Copper Alloys", *Comprehensive Nuclear Materials* (2012), Vol. 4, pp. 667-690





# Fracture Toughness

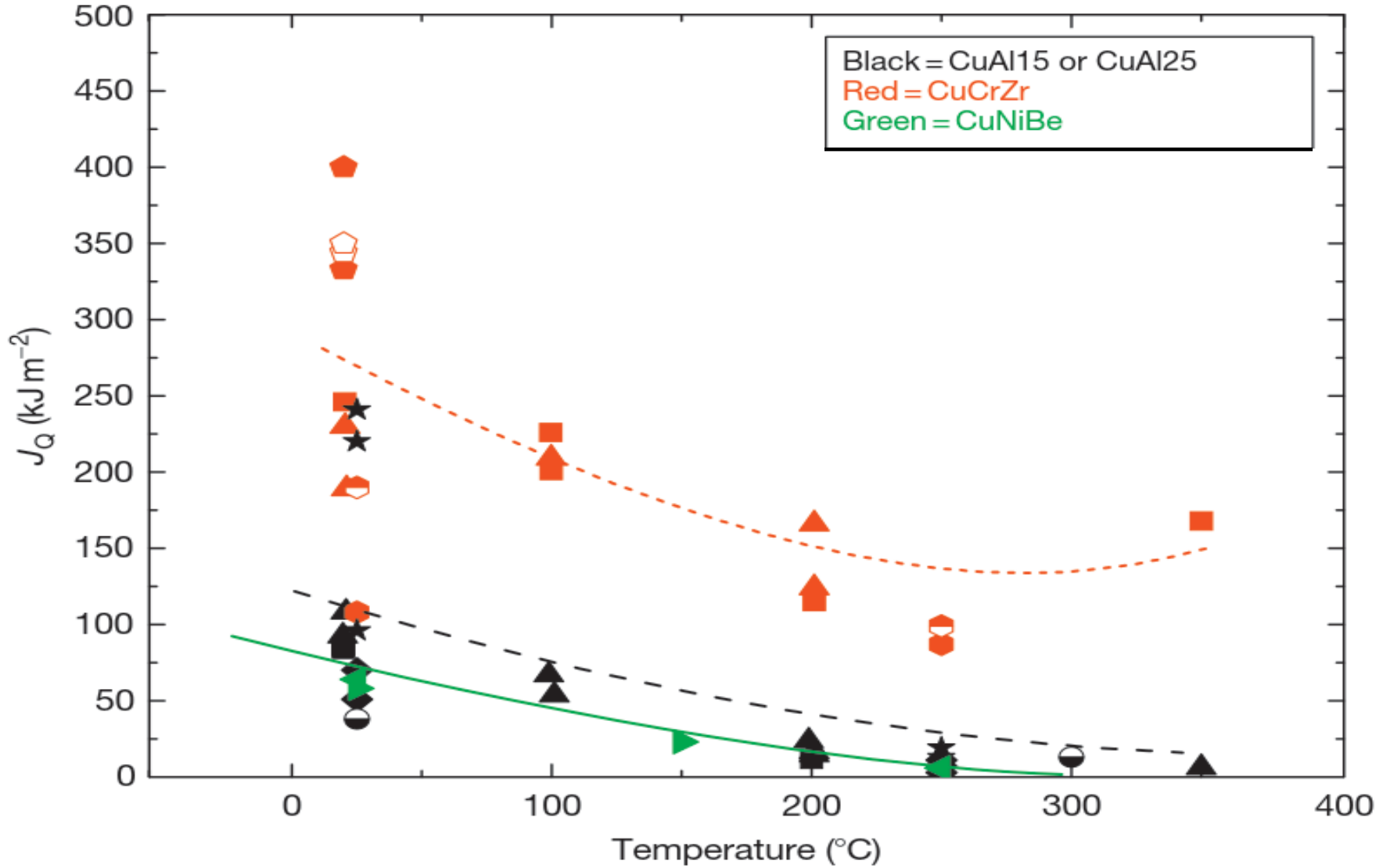

# Cornell Undulator Chamber made of CuCrZr

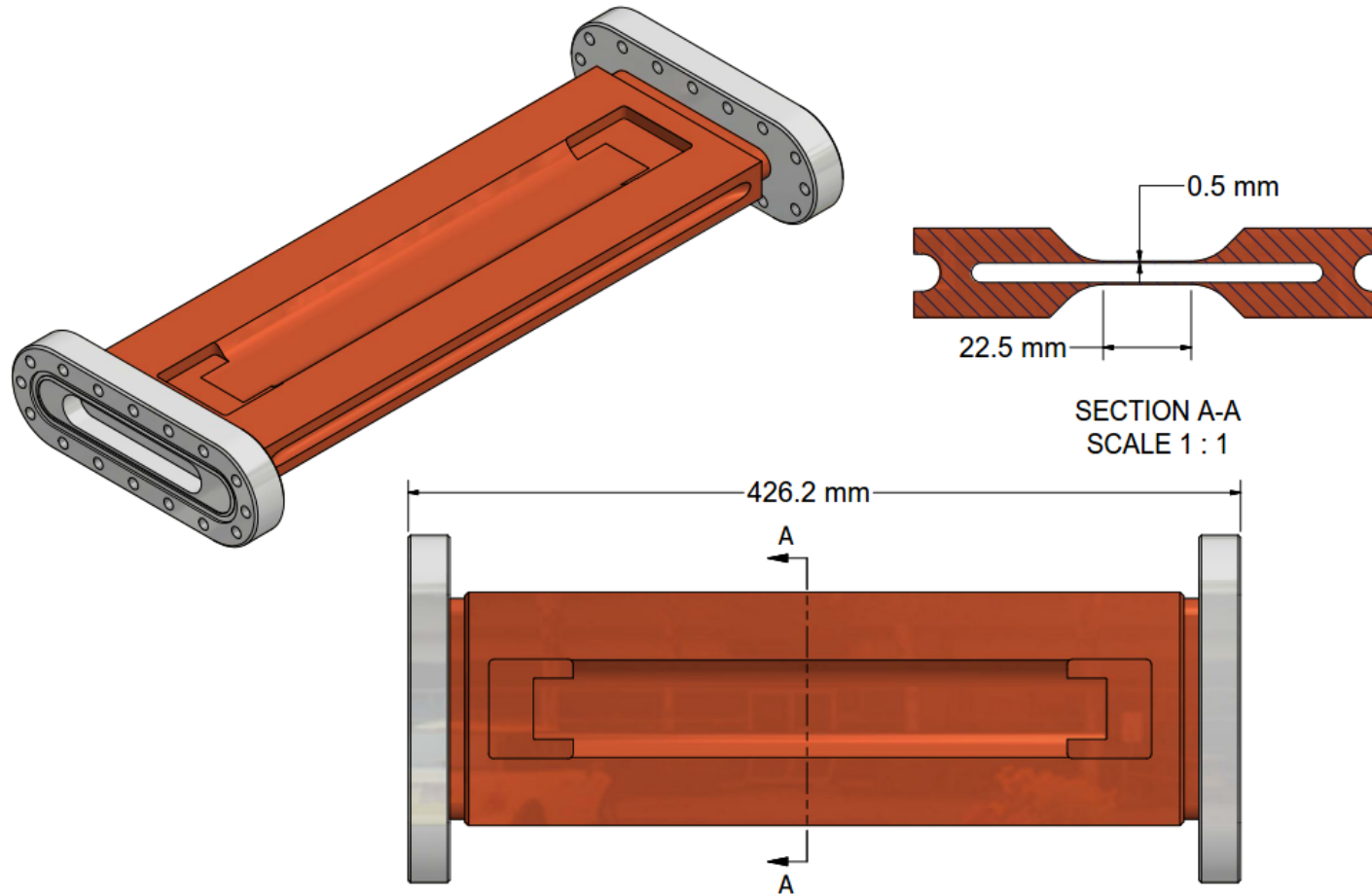

*PH Copper CuCrZr has excellent mechanical and thermal properties, thus was chosen for this thin-wall chamber. However, both Cr and Zr alloying elements may become radioactive by lost particles.*



**Glidcop is pure copper with  $\text{Al}_2\text{O}_3$  dispersed throughout.**

- *High strength, moderate formability, poor weldability.*
- *Available in sheets, plate, wire, and extruded rounds.*
- *Maintains good mechanical strength after brazing.*
- *Outgassing rates are similar to pure copper.*
- *Thermal and electrical properties are good.*

Grade Designations		Copper		$\text{Al}_2\text{O}_3$	
UNS	SCM Metal Prod.	Wt %	Vol %	Wt %	Vol %
C15715	Glidcop AL-15	99.7	99.3	0.3	0.7
C15725	Glidcop AL-25	99.5	98.8	0.5	1.2
C15760	Glidcop AL-60	98.9	97.3	1.1	2.7

Ref. SCM Metal Products

# Glidcop™ Physical Properties



Property	C15715	C15725	C15760	OFE Cu
Melting Point (°C)	1083	1083	1083	1083
Density (lb/in <sup>3</sup> )	0.321	0.320	0.318	0.323
Electrical Resistivity (Ω)	11.19	11.91	13.29	10.20
Elect. Conduct. (% IACS*)	92	87	78	101
Therm. Conduct. (W/m-K)	365	344	322	391
Coeff. Of Therm. Exp. (°C <sup>-1</sup> )	16.6×10 <sup>-6</sup>	16.6×10 <sup>-6</sup>	16.6×10 <sup>-6</sup>	17.7×10 <sup>-6</sup>
Mod. Of Elasticity (psi)	19×10 <sup>6</sup>	19×10 <sup>6</sup>	19×10 <sup>6</sup>	19×10 <sup>6</sup>

\* International Annealed copper Standard

Ref. SCM Metal Products



# Glidcop™ Mechanical Properties <sup>1</sup>



Grade	Form	Tensile Strength (ksi) <sup>2</sup>	Yield Strength (ksi) <sup>2</sup>
AL-15 (C15715)	Plate	53 ~ 70	37 ~ 66
	Rod	57 ~ 72	47 ~ 66
	Rounds	53	37
AL-25 (C15725)	Plate	60 ~ 76	43 ~ 68
	Rod	64 ~ 80	52 ~ 77
	Rounds	60	43
AL-60 (C15760)	Plate	--	--
	Rod	72 ~ 90	69 ~ 87
	Rounds	68	48
C10100		30 ~ 50	20 ~ 35

1. Ref. <http://www.hoganas.com>
2. Large spread reflect strength at different tempers



# NSLS II Crotch and Absorber Made of Glidcop™



Insertable  
Crotch

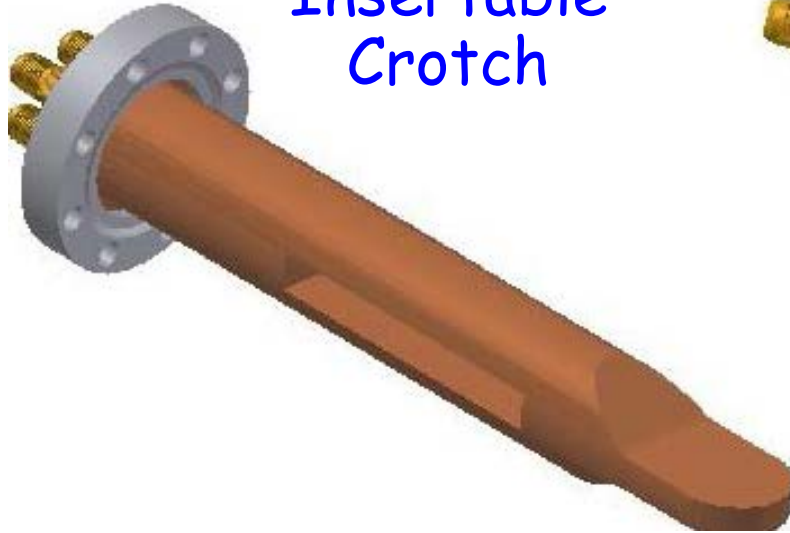

Stick Photon  
Absorber

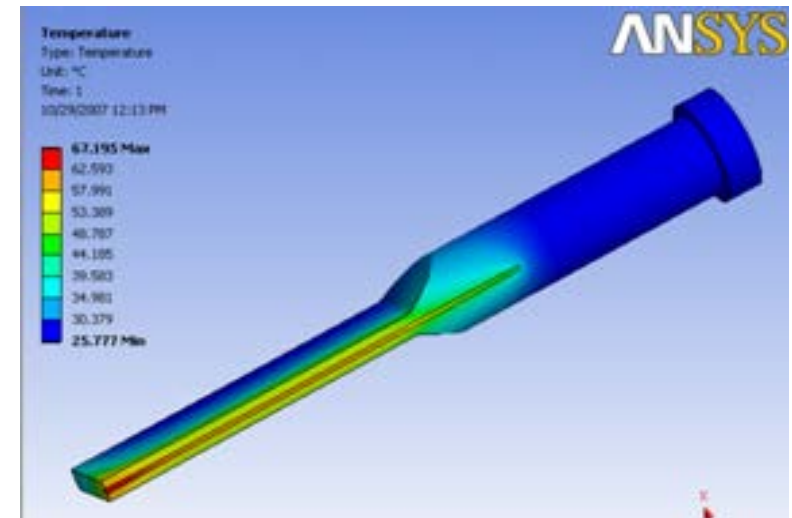
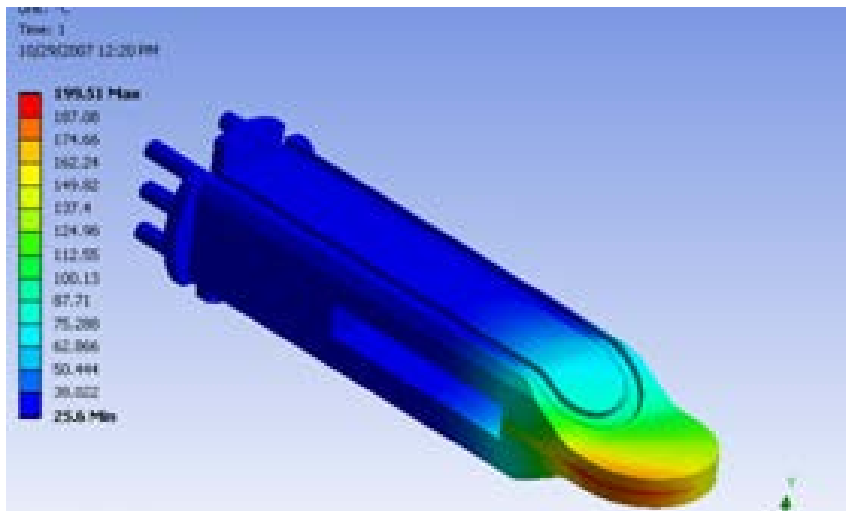
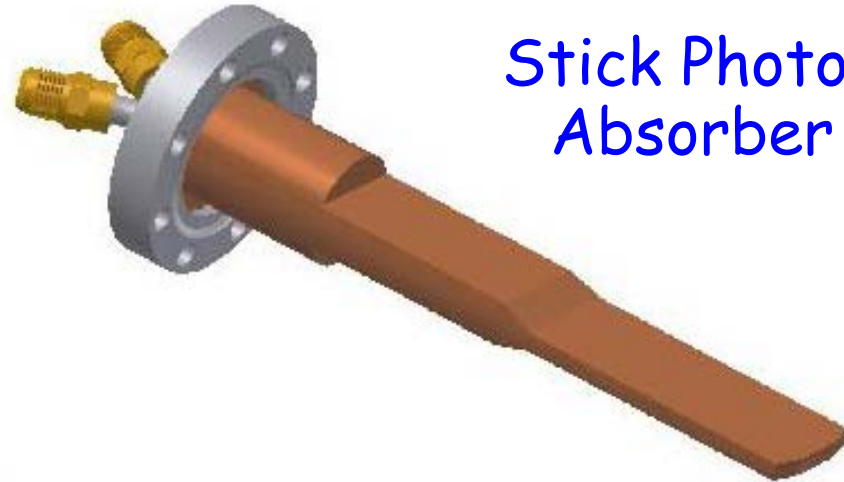

Ref: H. Hseuh, NSLS II, BNL



# Other Metals – Beryllium



- ❑ *Beryllium is the lightest metal with good mechanical strength and good thermal conductivity.*
- ❑ *Beryllium is machinable and can be jointed via vacuum braze or e-beam welding.*
- ❑ *Beryllium is hazard mat'l, must be handled by highly trained experts*



*Be Beampipe for CMS*



*UHV X-ray Windows*



*75µm Be  
e<sup>-</sup> Injection  
Window*

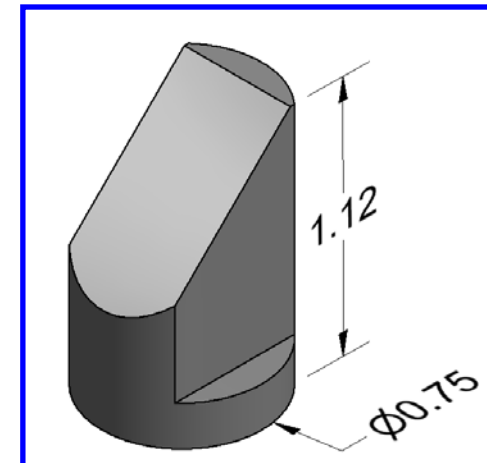

*SynchLight Mirror*



# Niobium & Titanium



- ❑ *High purity, small grain niobium is the key material for constructing superconducting RF cavities for many existing and future (such as Jlab, Cornell CESR and ERL, Tesla, ILC, etc.) facilities*
- ❑ *The grade of the Nb material is usually certified by so-called RRR (Residual-resistance ratio). Hydrogen in the Nb bulk is often degassed for high-Q cavities.*
- ❑ *To match CTE, titanium (grade 1 and grade 5) are used to joint to Nb cavities for flanges and helium vessels.*
- ❑ *E-beam welding is the primary technique for Nb and Ti.*

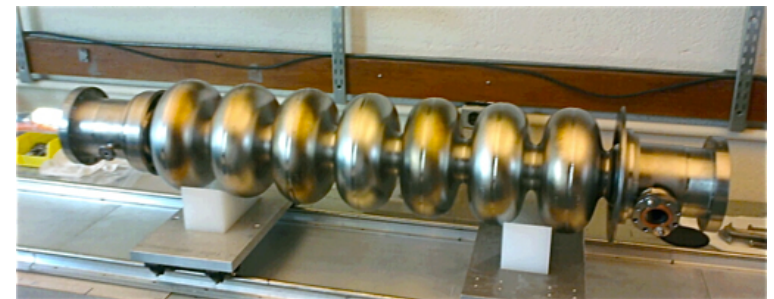



# C.T.E. of some metals

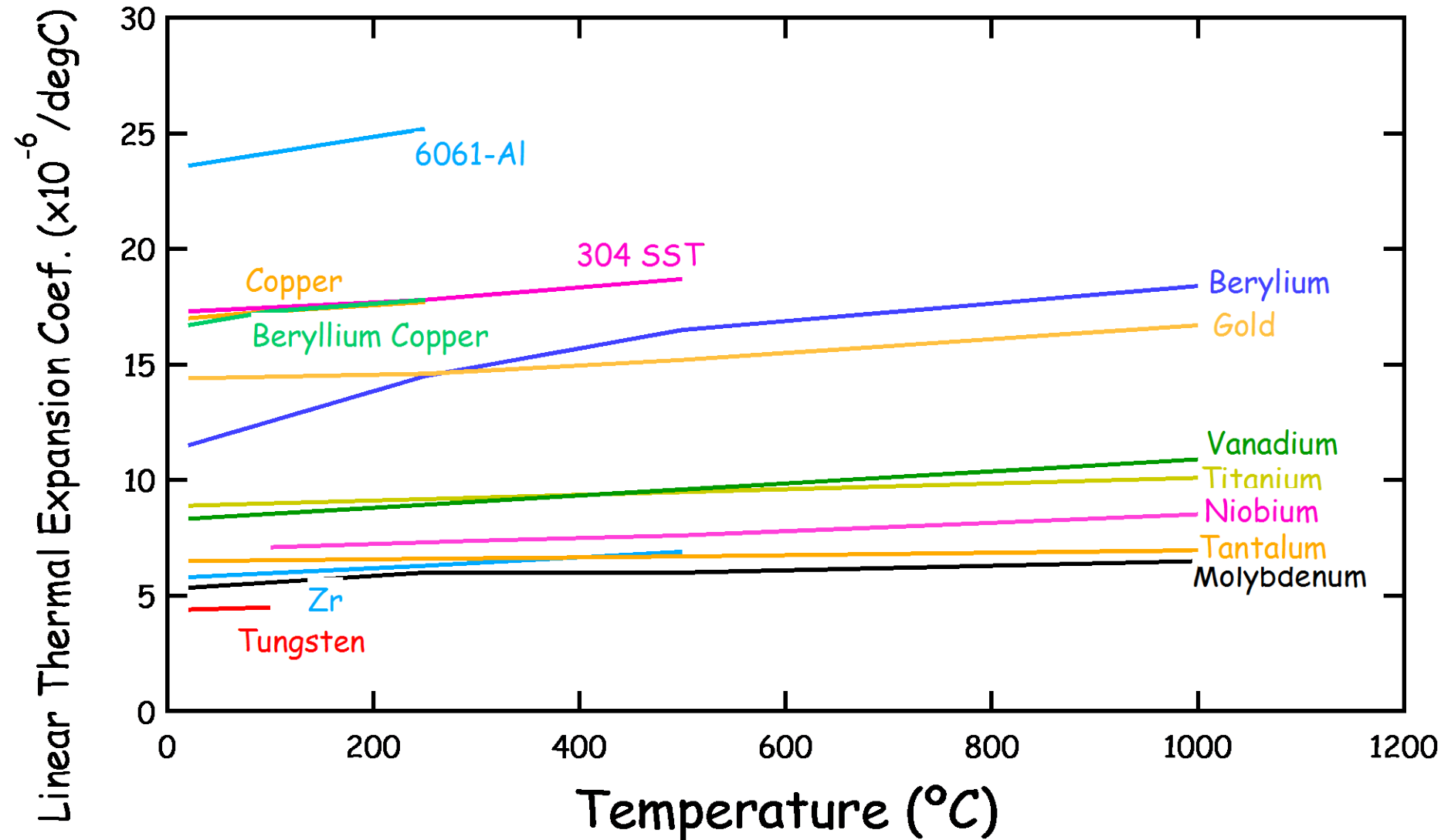

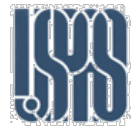

- ❑ *Alumina ceramics ( $Al_2O_3 > 99\%$ ) are widely used for electric breaks, instrument and electric power feedthroughs, RF windows in the accelerator vacuum systems.*
- ❑ *Alumina ceramic beam pipes with thin inner metallic coating are also used as a part of pulsed magnet for beam feedback, injection kickers, etc.*
- ❑ *Ceramics are jointed to metal flanges using vacuum furnace braze technique.*
- ❑ *Many type of glasses are used mainly as viewports on vacuum systems, for visual inspection of in-vacuum components, for light transmissions (laser entrance, beam profile viewers, etc.)*
- ❑ *Machined ceramic parts are UHV compatible. Special diamond-tipped tools are used for ceramic machining. There are also machinable ceramics, such Macor®.*



# Properties of Some Glasses for Vacuum



Property	Fused Silica	Pyrex 7740	7720 <sup>a</sup>	Soda 7052 <sup>a</sup>	0080	Lead 0120
Composition						
SiO <sub>2</sub>	100	81	73	65	73	56
B <sub>2</sub> O <sub>3</sub>		13	15	18		
Na <sub>2</sub> O		4	4	2	17	4
Al <sub>2</sub> O <sub>3</sub>		2	2	7	1	2
K <sub>2</sub> O				3		9
PbO			6			29
LiO				1		
Other				3	9	
Viscosity characteristics						
Strain point °C	956	510	484	436	473	395
Annealing point °C	1084	560	523	480	514	435
Softening point °C	1580	821	755	712	696	630
Working point °C	—	1252	1146	1128	1005	985
Expansion coefficient × 10 <sup>-7</sup> /°C	3.5	35	43	53	105	97
Shock temperature, 1/4-in. plate °C	1000	130	130	100	50	50
Specific gravity	2.20	2.23	2.35	2.27	2.47	3.05

Source. Reprinted with permission from Corning Glass Works, Corning, NY.

<sup>a</sup> 7720 glass is used for sealing to tungsten and 7052 glass is used for sealing to Kovar.



# Properties of Some Ceramics for Vacuum

**Table 16.6 Physical Properties of Some Ceramics**

Ceramic	Main Body Composition	Expansion Coefficient ( $\times 10^{-7}$ )	Softening Temperature ( $^{\circ}\text{C}$ )	Tensile Strength ( $10^6 \text{ kg/m}^2$ )	Specific Gravity
Steatite	$\text{MgOSiO}_2$	70–90	1400	6	2.6
Forsterite	$2\text{MgOSiO}_2$	90–120	1400	7	2.9
Zircon porcelain	$\text{ZnO}_2\text{SiO}_2$	30–50	1500	8	3.7
85% alumina	$\text{Al}_2\text{O}_3$	50–70	1400	14	3.4
95% alumina	$\text{Al}_2\text{O}_3$	50–70	1650	18	3.6
98% alumina	$\text{Al}_2\text{O}_3$	50–70	1700	20	3.8
Pyroceram 9696 <sup>a</sup>	Corderite ceramic	57	1250	14 <sup>b</sup>	2.6
Macor 9658 <sup>a</sup>	Fluro-phlogophite	94	800	10 <sup>b</sup>	2.52

*Source.* Reprinted with permission from *Vacuum*, 25, p. 469, G. F. Weston. Copyright 1975, Pergamon Press, Ltd.

<sup>a</sup> Reprinted with permission from Corning Glass Works, Corning, NY.

<sup>b</sup> Modulus of rupture.

# Non-Metals – Elastomers and Polymers

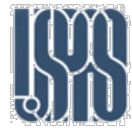

- ❑ *Elastomers, polymers and plastics have also found application in accelerator vacuum systems. Their vacuum properties and radiation resistance must be verified for the applications.*
- ❑ *Elastomers, particularly Viton® (fluorocarbon) are usually used as vacuum seals, often as gate seals for UHV gate valves.*
- ❑ *Though Teflon is UHV compatible, it is easily hardened and break down under radiation. PEEK (Polyether ether ketone) is a type of engineered plastics that is suitable for accelerator UHV applications. PEEK has good formability and machinability. The most uses are in vacuum multi-pin connectors.*
- ❑ *Kapton® (polyimide) films are suitable for accelerator UHV applications.*



PEEK Connectors

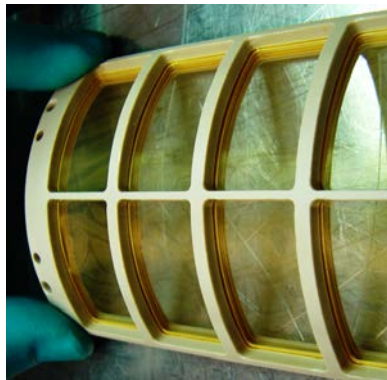

Machined PEEK

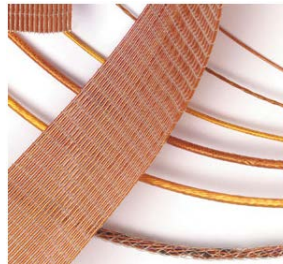

Kapton Coated Wires

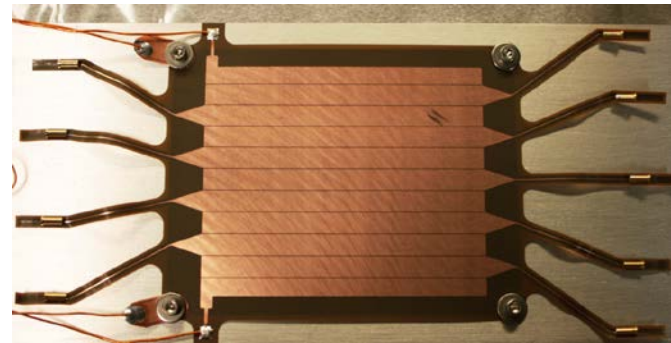

Cu-clad Kapton in-vacuum PCBs

# PEEK Material Can Be 'Gassy'

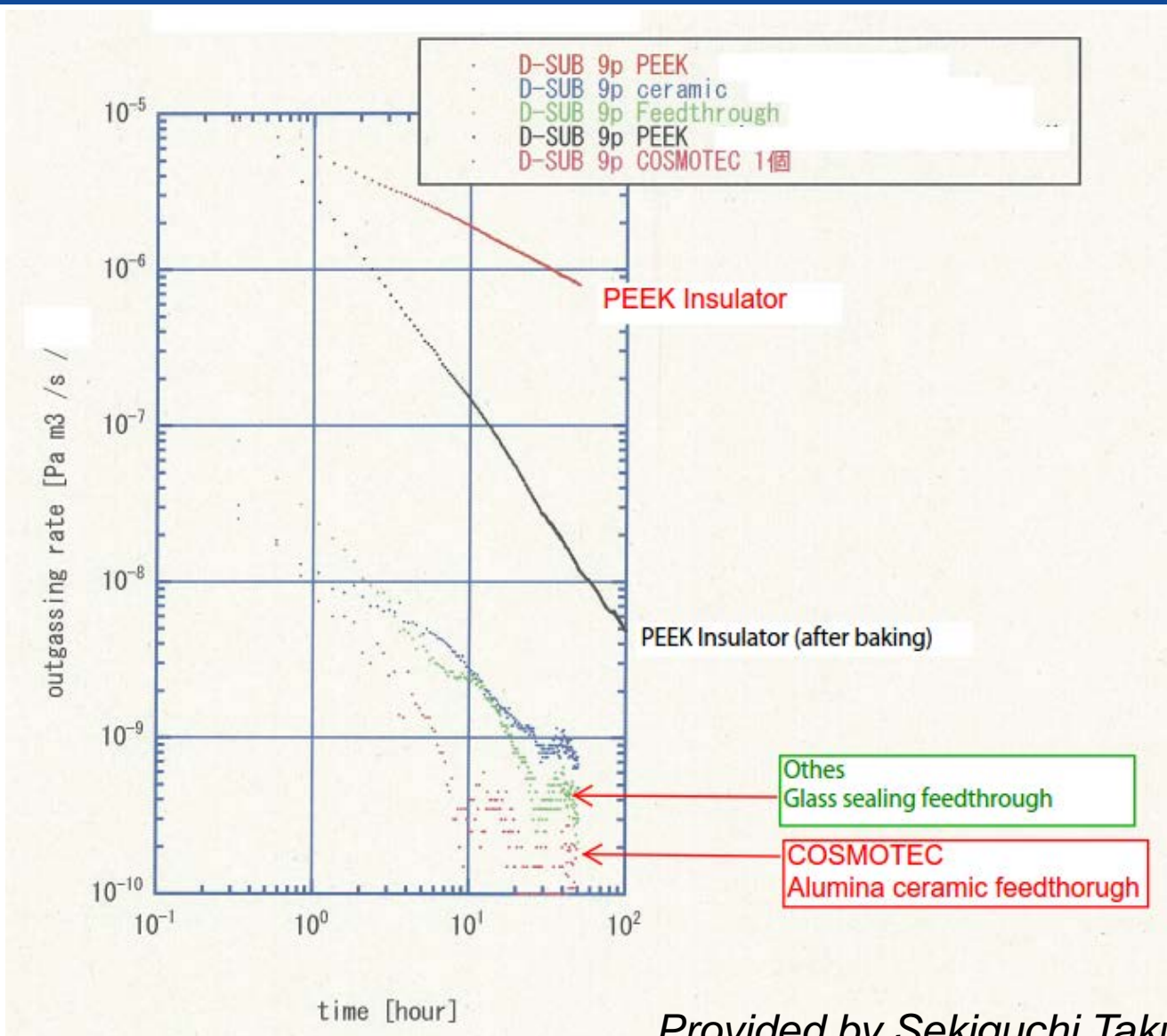
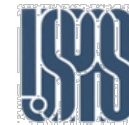

Provided by Sekiguchi Taku of [CosmoTec](http://www.cosmotec.com)



# Dry Lubrications in UHV Systems

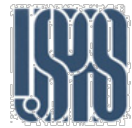

- ❑ *For in-vacuum movement that involves two metallic surfaces in contact, particularly two similar metals, lubrication between the contacting surfaces is necessary.*
- ❑ *For UHV applications, dry-lubrication is widely used. In a dry lubrication, the process of lubricating relies on a solid film.*
- ❑ *The desirable properties of a dry lubricant are low vapor pressure, low shear strength, and good adhesion to the base metal.*
- ❑ *Commonly used UHV-compatible dry lubricants are silver (electroplated),  $\text{MoS}_2$ ,  $\text{WS}_2$  (Dicronite®) (via PVD). Teflon coating is also a UHV-compatible dry lubricant, however, it is not durable in radiation environment.*

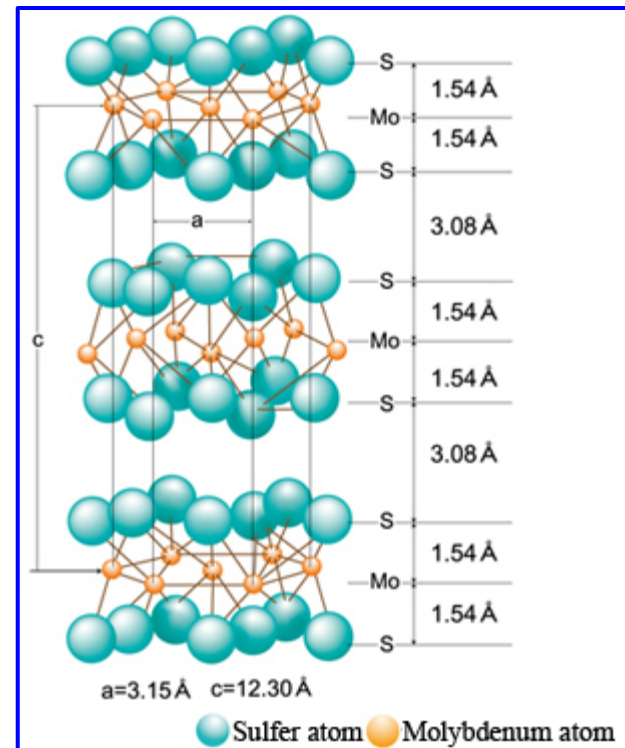

# UHV-compatible grease lubricants

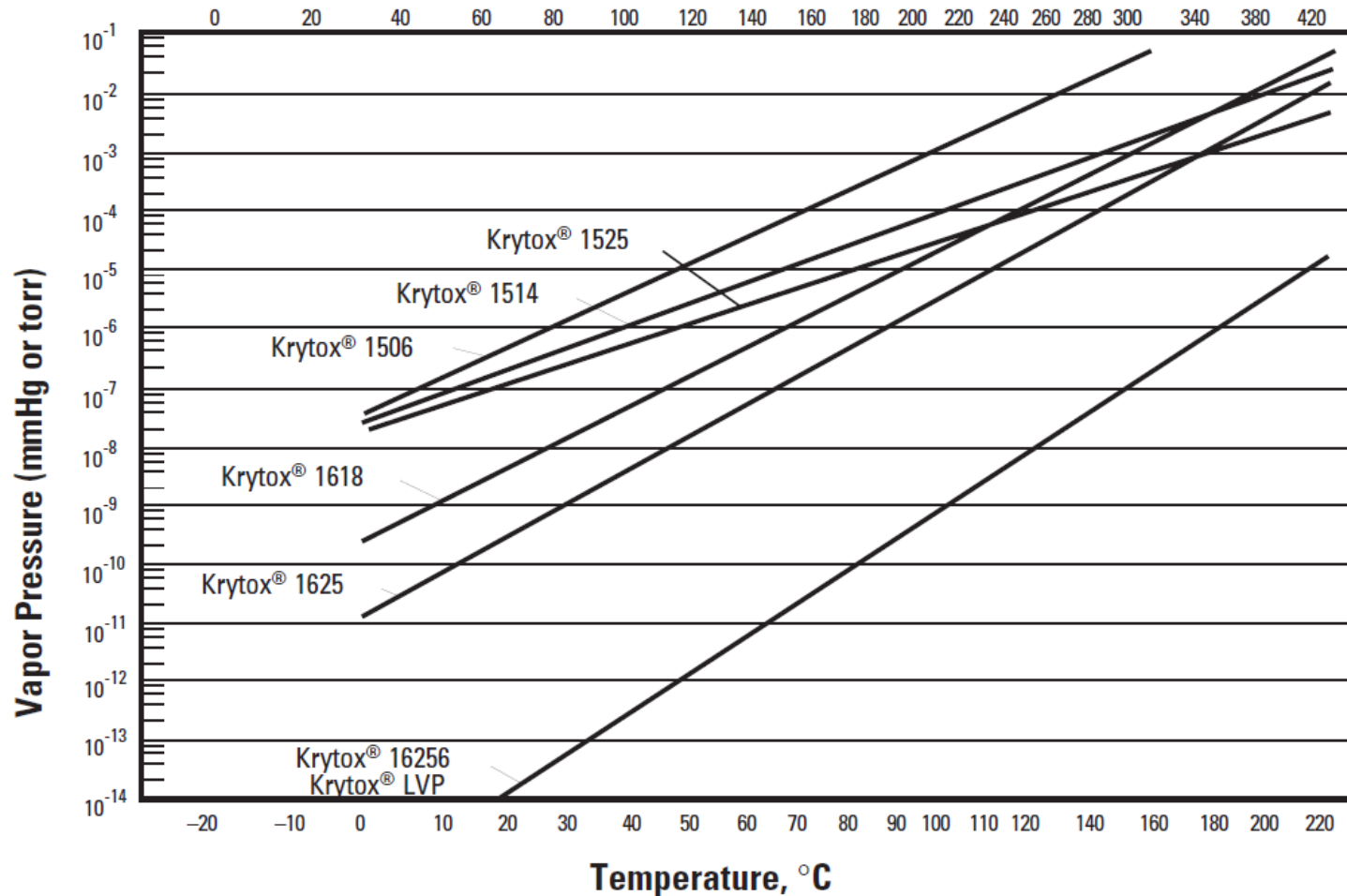

*However, extreme low vapor pressure may not be good enough in applications where energized desorption may occur.*



# Stimulated desorption of Krytox

